

本公司资料 版权所有 仿者必究
 公司备有详细资料 欢迎索取

- 本目录刊载的型号和规格会因产品更新而变化,恕不另行通知。
 If the models and specifications in this product catalogue is changed due to the change of products, we will not inform.
- 本目录虽然经多次校对,以求准确,但仅供参考之用,一切以实物及产品说明为准。
 This product Catalogue is checked by several times to be correct, but it is only for reference. All is according to products and user Instruction.



更多资料
www.gqele.com

GQ ELE 浙江高桥电子有限公司

GQ ELE 高桥电子
 GQ ELECTRONIC

- ◎ ISO9001 Quality Management System Certification
- ◎ CCC Product Certification.
- ◎ CE Product Certification.



GQ ELECTRONIC
 产品选型手册

Satisfy Every 追求每一细节 力求更加专业
 Customer By Our Professional Spirit

产品选型手册

- ◎ LED警示灯系列
 warning lamp series
- ◎ 按钮系列/金属按钮系列
 Push button series/ metal push button series
- ◎ AD116 信号灯系列
 AD116 signal lamp series
- ◎ LED灯头/LED灯珠系列
 LED burner/LED lamp series
- ◎ 交流接触器系列
 AC contactor series
- ◎ 控制盒系列
 Control box series
- ◎ 行车开关系列
 Travel switch series
- ◎ 防水接头系列
 Waterproof connector series

GQ ELE 浙江高桥电子有限公司
 ZHEJIANG GQ ELECTRONIC CO.,LTD.

Http://www.gqele.com
 E-mail:sales@gqele.com



2017-5
 VERSION

2017-5
 VERSION

浙江高桥电子有限公司
 ZHEJIANG GQ ELECTRONIC CO.,LTD.

Brief Introduction 企业简介

浙江高桥电子有限公司创建于2004年，是一家工控产品研发和生产的专业制造厂商；主要产品有LED指示灯、按钮、蜂鸣器、PG防水接头、接触器及LED元器件等系列，其广泛应用于控制柜、配电柜、仪表柜及各类控制台中；

公司在产品设计制造方面积累了丰富的经验，除本公司提供的产品型号及技术参数外，可根据客户要求设计制造，满足和适应客户多方面的要求；

多年来公司坚持以“科技创新，真诚服务”的经营理念，深得各界人士及新老客户的一致好评。高桥电子全体员工正满怀信心、积极开拓，迎接新的机遇和挑战，愿与海内外客商携手并进，共创美好明天！

Zhejiang GaoQiao Electronic Co.,Ltd (GQ ELECTRONIC) was founded in 2004. It is a professional manufacturer engaged in researching and developing industrial products. Main products include LED indicator light, push button switch, buzzer, PG waterproof connectors, AC contactors and LED components, which is widely used in the control cabinets, power distribution cabinets, instrument cabinets and various types of consoles.

The company has accumulated rich experience in product design and manufacturing. In addition to the models and technical parameters provided by the company, it can design and manufacture according to the various requests of customers in order to satisfy and meet the customers' needs.

Over the years, the company adhere to the "science and technology innovation, sincere service" business philosophy, won the praise of people from all the new and old customers. All the staff of Gaoqiao electronic co. are full of confidence to explore and meet new opportunities and challenges and willing to work with customers from home and abroad for a better tomorrow!

GQELE 高桥电子
GQ ELECTRONIC

www.gqele.com

Satisfy Every 追求每一细节 力求更加专业
Customer By Our Professional Spirit

优质品牌 世界共享

从我们的足迹印在世界每一个角落那一刻起，
我们就不仅仅属于中国，
而是世界人民共有。

一直以来，我们都致力于为世界各国人民提供更为优异的产品，
把我们的产品推向世界每一个角落；
不同国家，相同的是对我们品牌的情感。
我们将跨越国界，奋力向前！



Certificate 企业证书



一丝不苟 千锤百炼

标准化的管理体系和系统化的品质保证

以自强不息的精神

将事业推向了崭新的领域 为客户提供满意服务

Being conscientious and meticulous ,Being highly finished

Standardized management system and systemized quality assurance

With the spirit of constantly striving to become stronger

push the business to a brand-new field, Sincerely provide satisfactory service for customers



Exploring Innovation Field Going Forward
Technique Future
科技开创未来，真诚服务永远

品牌 一路畅通





Products Catalog / 目录

A	AL-LED警示灯系列 AL-LED warning lamp series	001-008
B	LA115-A/B按钮系列 LA115-A/B push button series	009-025
C	GXB2/GXB4按钮系列 GXB2/GXB4 push button series	026-040
D	LAY7按钮系列/按钮附件 LAY7 push button/parts of push button series	041-044
E	LA115-C按钮系列/金属按钮系列 LA115-C push button / metal push button series	045-054
F	AD116 信号灯系列 AD116 signal lamp series	055-060
G	LED灯头/LED灯珠系列 LED burner /LED lamp series	061-065
H	交流接触器系列 AC contactor series	066-073
I	控制盒/行车开关系列 Control box/Travel switch series	074-079
J	防水接头系列 Waterproof connector series	080-080

.....如需详细产品资料请登陆 [地址 http://www.gqele.com/](http://www.gqele.com/)  转到

AL-LED警示灯系列 warning lamp series

- 采用高亮LED发光源 LED lamp with high brightness
- 警报喇叭声可多样选择且带延时关闭功能
Alarming trumpet with several options, closed after minutes' alarm
- 多功能一体式可自由选择显示方式 Several shining ways to choose from
- 单个独立体模组式可自由拼装
Each single section works independently, can be put together at customers' request
- 防护等级IP65能适应特殊工作环境 Protection grade ip65, can adapt special environment

选型说明 TYPE AND MEANING

AL - R Y G B W M - 2 8 P Y

Y: 增加预装底座
Add the base

电压 Voltage :

AC.DC - 22 : 12V
23 : 24V
24 : 36V
25 : 48V

AC - 30 : 110V
31 : 220V
32 : 380V

**AL50立杆尺寸
Poling Scale(mm) :**

1-87 / 2-142 / 3-242

**AL70/90立杆尺寸
Poling Scale(mm) :**

1-58 / 2-88 / 3-118
4-168 / 5-218
6-268 / 7-318

P: 竖装座 Vertical base

Z: 可折叠万向底座 Collapsible Universal base

C: 侧向安装基座 Side mounting base

无字母 平装底座 No letters (Paperback base)

M: 带蜂鸣器 With buzzer

M后面带数字 Behind M with Digital :

1: 连续叫 Continuous Ring

2: 间断叫 Discontinuous Ring

3: 间断叫延时关闭 Discontinuous Ring, delay close

无数字代表间断叫
No Digital representative Discontinuous Ring

**塔灯自上而下每一段发光颜色
Tower Lamp from Top to Bottom,
Each section emitting color**

● R : red ● G : green
● Y : yellow ● W : white
● B : blue

**颜色后面带数字 :
The behind of the color,
with digital**

1: 常亮 Ordinary Shiny
2: 转亮 Light Brighter
3: 爆闪 Light Flash Blasting

**无数字代表普通闪亮
No Digital representative
Ordinary Shiny**

**经济型只有“常亮”和
“闪亮”两种发光模式
There are only two modes
of luminescence in economy:
"ordinary shiny" and "Twinkle".**

**外形尺寸及样式
Outline dimension
Appearance and Style**

50 : 50模组式 Modular
50E: 50经济型模组式
Economical modular

70 : 70模组式 Modular
70E: 70经济型模组式
Economical modular

702 : 70平装 Flat Stitching
702E: 70平装 Flat Stitching
(经济型 Economical type)

701 : 70单灯式 Single Lamp Style
701E: 70单灯式 Single Lamp Style
(经济型 Economical type)

801 : 80单灯式 Single Lamp Style
901 : 90单灯式 Single Lamp Style

接线图 WIRING DIAGRAM

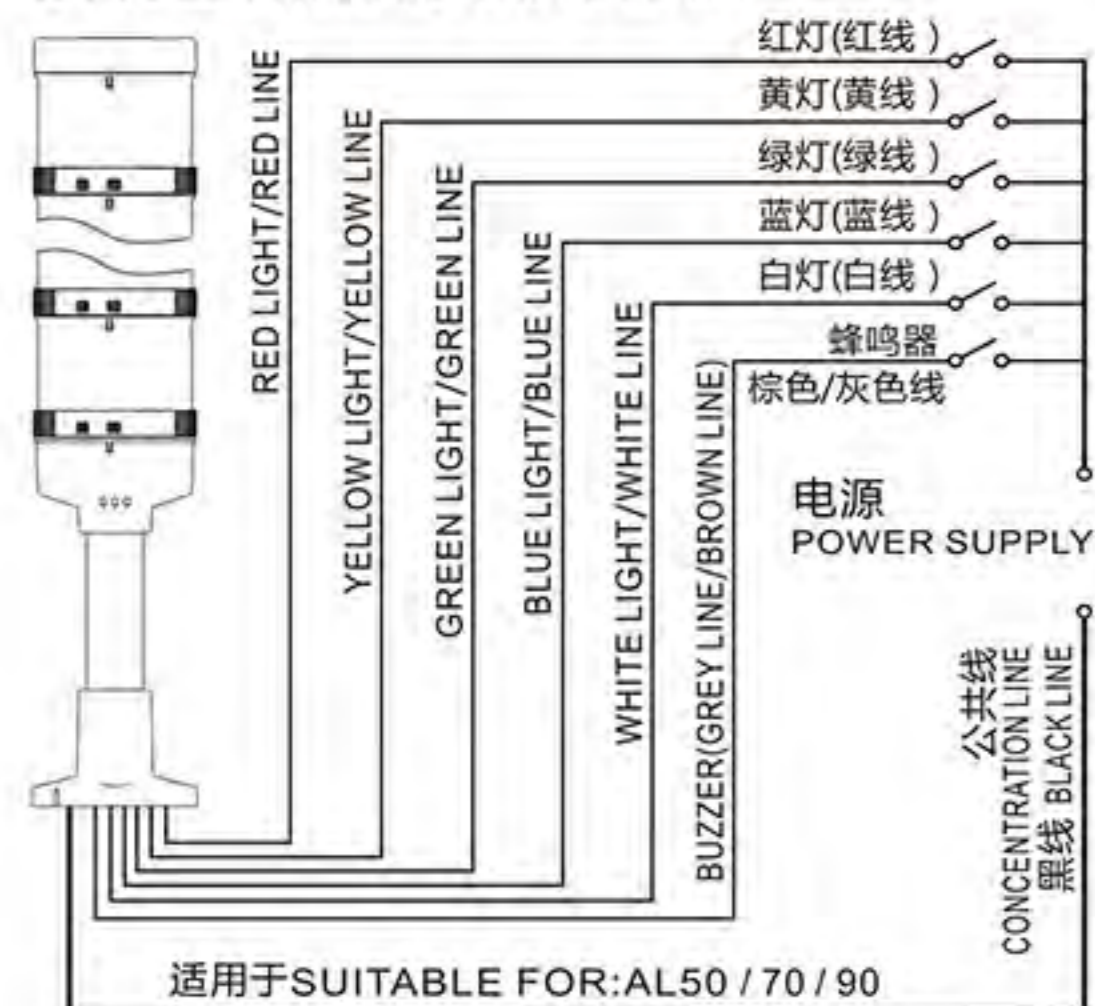

LED发光形式 Glowing Form

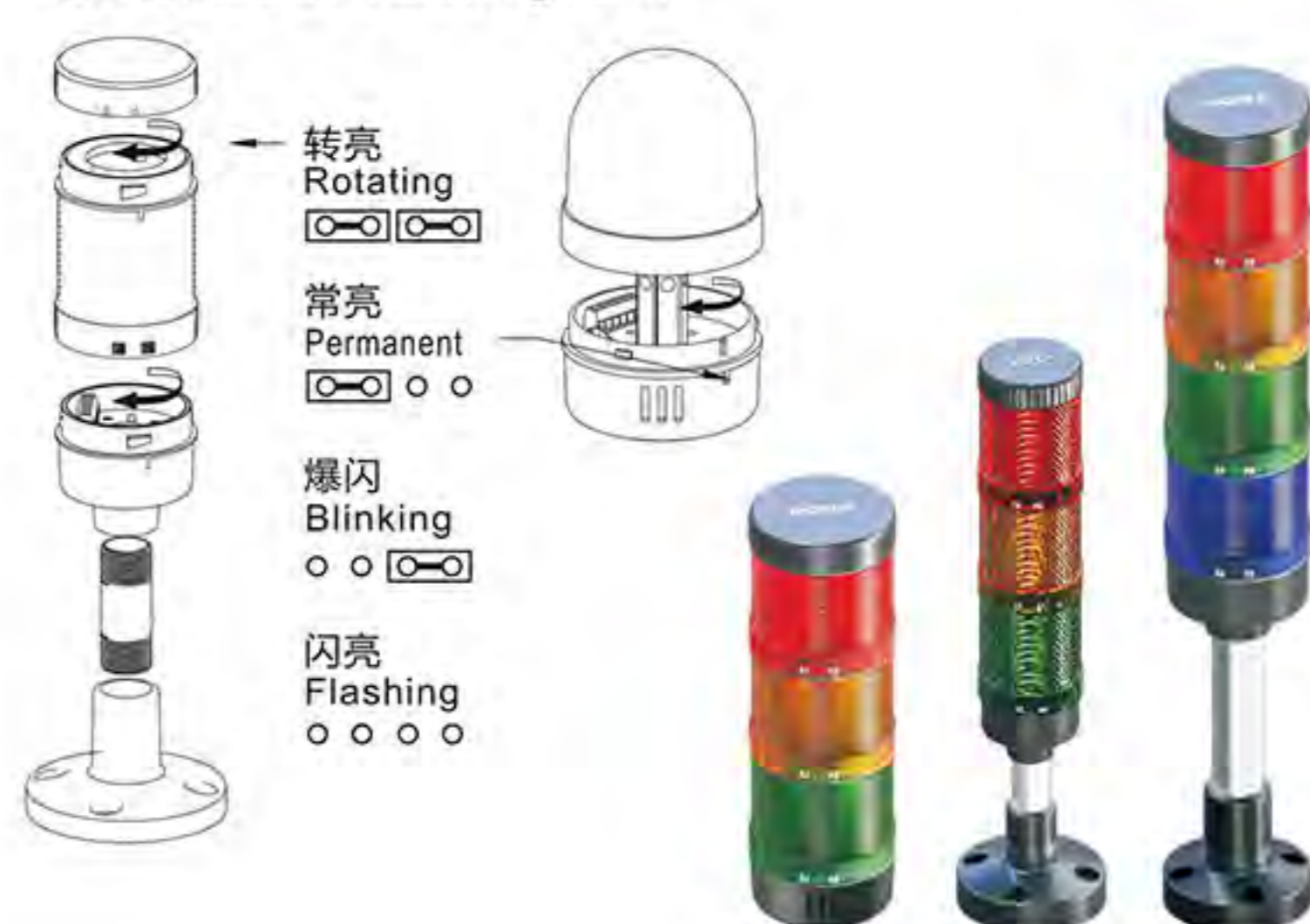

样式 Product style	描述 Product description	型号 Model	尺寸 Contour
	AL50系列 单节红色 (无蜂鸣器) 1Layer red (Without buzzer)	竖装座 Vertical base AL50-R-31P2	
	AC220V 侧装座 Side mounting base AL50-R-31C3	折叠座 Collapsible Universal base AL50-R-31Z2	
	单节红色 (有蜂鸣器) 1Layer red (With buzzer)	竖装座 Vertical base AL50-RM-31P2	
	AC220V 侧装座 Side mounting base AL50-RM-31C3	折叠座 Collapsible Universal base AL50-RM-31Z2	
	单节多色 (无蜂鸣器) 1Layer multicolor (Without buzzer)	竖装座 Vertical base AL501-RGB-23P2	
	AC/DC24V 侧装座 Side mounting base AL501-RGB-23C3	折叠座 Collapsible Universal base AL501-RGB-23Z2	
	单节多色 (有蜂鸣器) 1Layer multicolor (With buzzer)	竖装座 Vertical base AL501-RGBM-23P2	
	AC/DC24V 侧装座 Side mounting base AL501-RGBM-23C3	折叠座 Collapsible Universal base AL501-RGBM-23Z2	

AL50系列	1节红色 1Layer red	AL50-R-31P2	
竖装座 (无蜂鸣器) Vertical base (Without buzzer)	2节红.绿 2Layer R.G	AL50-RG-31P2	
AC 220V	3节红.黄.绿 3Layer R.Y.G	AL50-RYG-31P2	
4节红.黄.绿.蓝 4Layer R.Y.G.B	AL50-RYGB-31P2		
5节红.黄.绿.蓝.白 5Layer R.Y.G.B.W	AL50-RYGBW-31P2		
1节红色 1Layer red	AL50-RM-23P2		
竖装座 (有蜂鸣器) Vertical base (With buzzer)	2节红.绿 2Layer R.G	AL50-RGM-23P2	
AC/DC 24V	3节红.黄.绿 3Layer R.Y.G	AL50-RYGM-23P2	
4节红.黄.绿.蓝 4Layer R.Y.G.B	AL50-RYGBM-23P2		
5节红.黄.绿.蓝.白 5Layer R.Y.G.B.W	AL50-RYGBWM-23P2		

注：出厂默认配置为发光单元“红灯、黄灯”闪亮，“绿灯、蓝灯、白灯”常亮；“蜂鸣器”间断响；壳体分黑色和白色两种，不同型号默认颜色不同，如有要求请在下单时另行注明。

样式 Product style

描述 Product description

型号 Model

尺寸 Contour

AL50系列



折叠座
Collapsible Universal base

无蜂鸣器 Without buzzer AC 220V	1节红色 1Layer red	AL50-R-31Z2
	2节红.绿 2Layer R.G	AL50-RG-31Z2
	3节红.黄.绿 3Layer R.Y.G	AL50-RYG-31Z2
	4节红.黄.绿.蓝 4Layer R.Y.G.B	AL50-RYGB-31Z2
	5节红.黄.绿.蓝.白 5Layer R.Y.G.B.W	AL50-RYGBW-31Z2
有蜂鸣器 With buzzer AC/DC 24V	1节红色 1Layer red	AL50-RM-23Z2
	2节红.绿 2Layer R.G	AL50-RGM-23Z2
	3节红.黄.绿 3Layer R.Y.G	AL50-RYGM-23Z2
	4节红.黄.绿.蓝 4Layer R.Y.G.B	AL50-RYGBM-23Z2
	5节红.黄.绿.蓝.白 5Layer R.Y.G.B.W	AL50-RYGBWM-23Z2

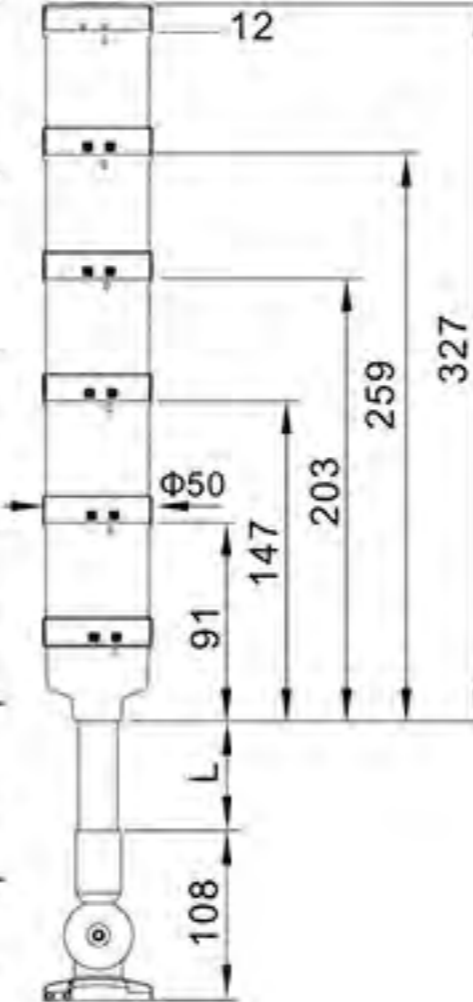

AL50系列



侧装座
Side mounting base

无蜂鸣器 Without buzzer AC 220V	1节红色 1Layer red	AL50-R-31C3
	2节红.绿 2Layer R.G	AL50-RG-31C3
	3节红.黄.绿 3Layer R.Y.G	AL50-RYG-31C3
	4节红.黄.绿.蓝 4Layer R.Y.G.B	AL50-RYGB-31C3
	5节红.黄.绿.蓝.白 5Layer R.Y.G.B.W	AL50-RYGBW-31C3
有蜂鸣器 With buzzer AC/DC 24V	1节红色 1Layer red	AL50-RM-23C3
	2节红.绿 2Layer R.G	AL50-RGM-23C3
	3节红.黄.绿 3Layer R.Y.G	AL50-RYGM-23C3
	4节红.黄.绿.蓝 4Layer R.Y.G.B	AL50-RYGBM-23C3
	5节红.黄.绿.蓝.白 5Layer R.Y.G.B.W	AL50-RYGBWM-23C3

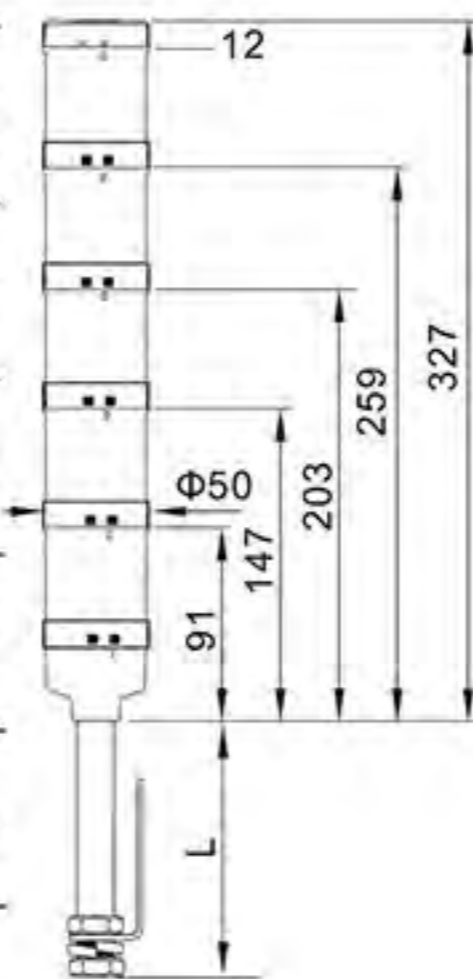

注：出厂默认配置为发光单元“红灯、黄灯”闪亮，“绿灯、蓝灯、白灯”常亮；“蜂鸣器”间断响；壳体分黑色和白色两种，不同型号默认颜色不同，如有要求请在下单时另行注明。

样式 Product style

描述 Product description

型号 Model

尺寸 Contour

AL701系列



平装座
Paperback base

圆头红色 (无蜂鸣器) Round head red (Without buzzer) AC220V	平装座 Paperback base	AL701-R-31
圆头红色 (带蜂鸣器) Round head red (With buzzer) AC220V	平装座 Paperback base	AL701-RM-31
圆头多色 (无蜂鸣器) Round head multicolor (Without buzzer) AC/DC 24V	平装座 Paperback base	AL701-RGB-23
圆头多色 (带蜂鸣器) Round head multicolor (With buzzer) AC/DC 24V	平装座 Paperback base	AL701-RGBM-23

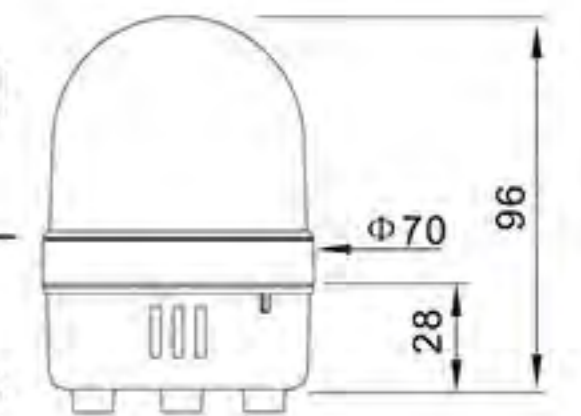

AL701系列



侧装座
Side mounting base

竖装座
Vertical base

折叠座
Collapsible Universal base

圆头红色 (无蜂鸣器) Round head red (Without buzzer) AC220V	竖装座 Vertical base	AL701-R-31P4
圆头红色 (带蜂鸣器) Round head red (With buzzer) AC220V	折叠座 Collapsible Universal base	AL701-R-31Z4
圆头多色 (无蜂鸣器) Round head multicolor (Without buzzer) AC/DC 24V	侧装座 Side mounting base	AL701-R-31C5
圆头多色 (带蜂鸣器) Round head multicolor (With buzzer) AC/DC 24V	侧装座 Side mounting base	AL701-R-31C5
圆头多色 (无蜂鸣器) Round head multicolor (Without buzzer) AC/DC 24V	竖装座 Vertical base	AL701-RM-31P4
圆头多色 (带蜂鸣器) Round head multicolor (With buzzer) AC/DC 24V	折叠座 Collapsible Universal base	AL701-RM-31Z4
圆头多色 (无蜂鸣器) Round head multicolor (Without buzzer) AC/DC 24V	侧装座 Side mounting base	AL701-RM-31C5
圆头多色 (带蜂鸣器) Round head multicolor (With buzzer) AC/DC 24V	侧装座 Side mounting base	AL701-RM-31C5
圆头多色 (无蜂鸣器) Round head multicolor (Without buzzer) AC/DC 24V	竖装座 Vertical base	AL701-RGB-23P4
圆头多色 (带蜂鸣器) Round head multicolor (With buzzer) AC/DC 24V	折叠座 Collapsible Universal base	AL701-RGB-23Z2
圆头多色 (无蜂鸣器) Round head multicolor (Without buzzer) AC/DC 24V	侧装座 Side mounting base	AL701-RGB-23C5
圆头多色 (带蜂鸣器) Round head multicolor (With buzzer) AC/DC 24V	侧装座 Side mounting base	AL701-RGB-23C5
圆头多色 (无蜂鸣器) Round head multicolor (Without buzzer) AC/DC 24V	竖装座 Vertical base	AL701-RGBM-23P2
圆头多色 (带蜂鸣器) Round head multicolor (With buzzer) AC/DC 24V	折叠座 Collapsible Universal base	AL701-RGBM-23Z2
圆头多色 (无蜂鸣器) Round head multicolor (Without buzzer) AC/DC 24V	侧装座 Side mounting base	AL701-RGBM-23C5

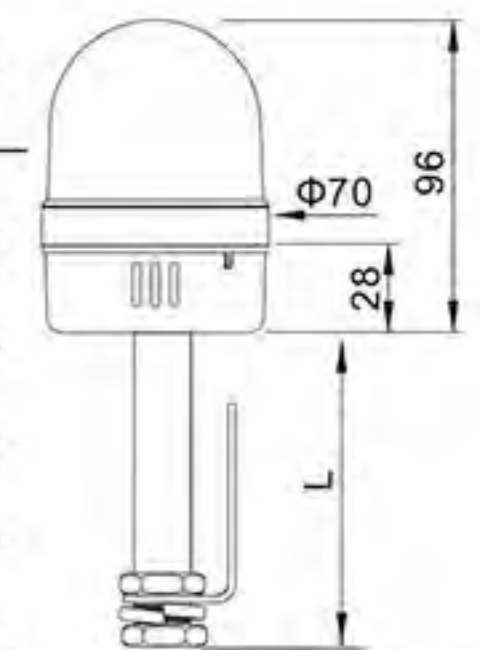
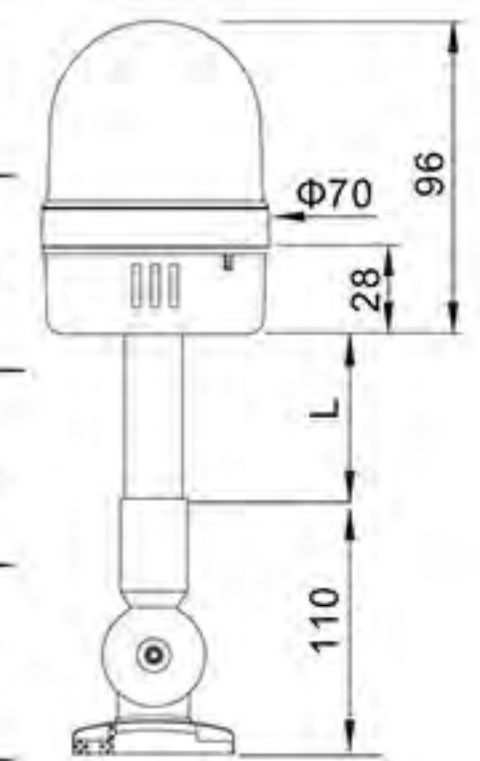
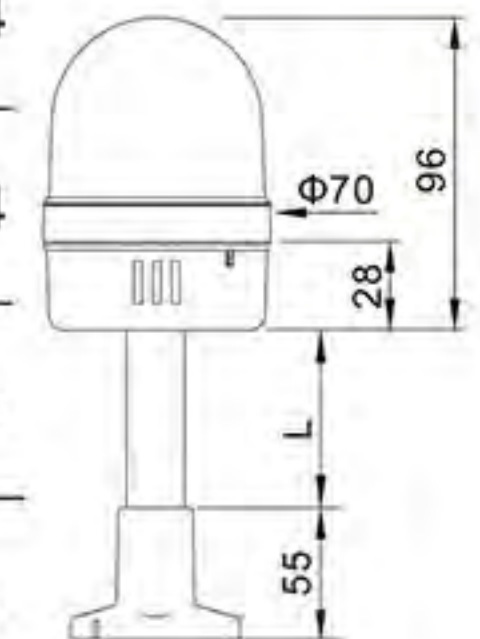

注：出厂默认配置为发光单元“红灯、黄灯”闪亮，“绿灯、蓝灯、白灯”常亮；“蜂鸣器”间断响；壳体分黑色和白色两种，不同型号默认颜色不同，如有要求请在下单时另行注明。

样式 Product style

描述 Product description

型号 Model

尺寸 Contour

AL70系列



平装座
Paperback base

1节红色 1Layer red	AL702-R-31
平装座 (无蜂鸣器) Paperback base (Without buzzer)	
2节红.绿 2Layer R.G	AL702-RG-31
3节红.黄.绿 3Layer R.Y.G	AL702-RYG-31
AC 220V	
4节红.黄.绿.蓝 4Layer R.Y.G.B	AL702-RYGB-31
5节红.黄.绿.蓝.白 5Layer R.Y.G.B.W	AL702-RYGBW-31
平装座 (有蜂鸣器) Paperback base (With buzzer)	
1节红色 1Layer red	AL702-RM-23
2节红.绿 2Layer R.G	AL702-RGM-23
3节红.黄.绿 3Layer R.Y.G	AL702-RYGM-23
AC/DC 24V	
4节红.黄.绿.蓝 4Layer R.Y.G.B	AL702-RYGBM-23
5节红.黄.绿.蓝.白 5Layer R.Y.G.B.W	AL702-RYGBWM-23

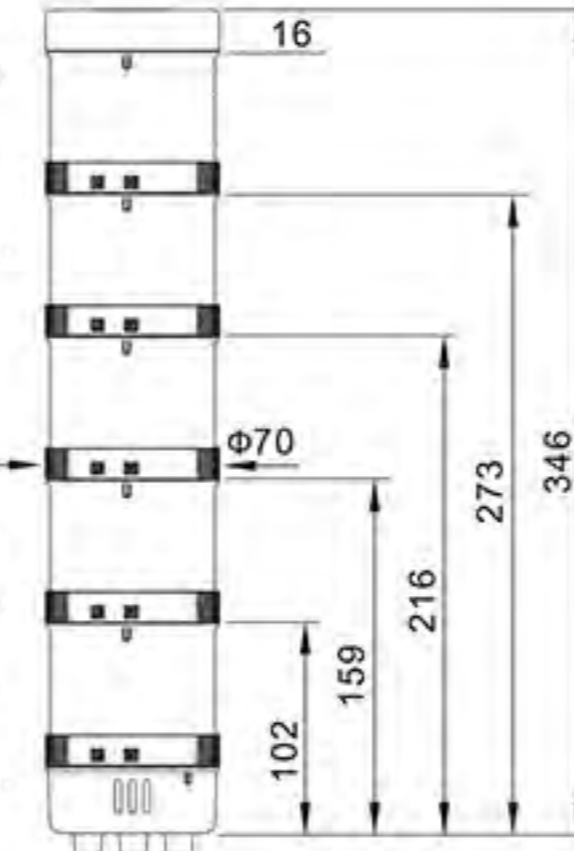

AL70系列



竖装座
Vertical base

1节红色 1Layer red	AL70-R-31P4
竖装座 (无蜂鸣器) Vertical base (Without buzzer)	
2节红.绿 2Layer R.G	AL70-RG-31P4
3节红.黄.绿 3Layer R.Y.G	AL70-RYG-31P4
AC 220V	
4节红.黄.绿.蓝 4Layer R.Y.G.B	AL70-RYGB-31P4
5节红.黄.绿.蓝.白 5Layer R.Y.G.B.W	AL70-RYGBW-31P4
竖装座 (有蜂鸣器) Vertical base (With buzzer)	
1节红色 1Layer red	AL70-RM-23P4
2节红.绿 2Layer R.G	AL70-RGM-23P4
3节红.黄.绿 3Layer R.Y.G	AL70-RYGM-23P4
AC/DC 24V	
4节红.黄.绿.蓝 4Layer R.Y.G.B	AL70-RYGBM-23P4
5节红.黄.绿.蓝.白 5Layer R.Y.G.B.W	AL70-RYGBWM-23P4

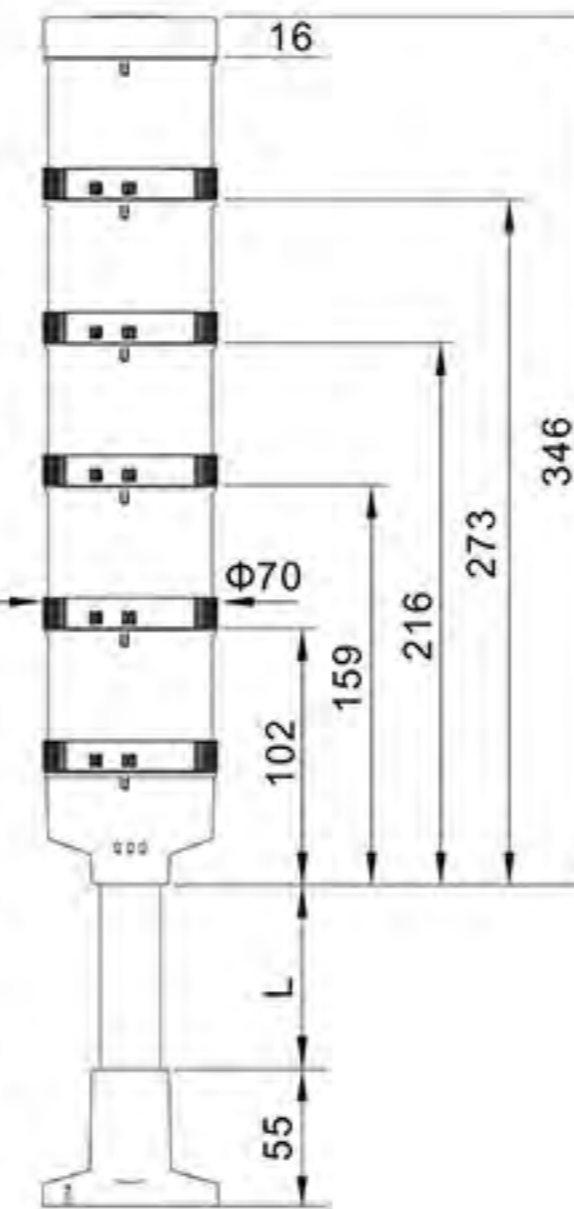

注：出厂默认配置为发光单元“红灯、黄灯”闪亮，“绿灯、蓝灯、白灯”常亮；“蜂鸣器”间断响；壳体分黑色和白色两种，不同型号默认颜色不同，如有要求请在下单时另行注明。

样式 Product style

描述 Product description

型号 Model

尺寸 Contour

AL70系列



折叠座
Collapsible Universal base

1节红色 1Layer red	AL70-R-31Z4
无蜂鸣器 Without buzzer	
2节红.绿 2Layer R.G	AL70-RG-31Z4
3节红.黄.绿 3Layer R.Y.G	AL70-RYG-31Z4
AC 220V	
4节红.黄.绿.蓝 4Layer R.Y.G.B	AL70-RYGB-31Z4
5节红.黄.绿.蓝.白 5Layer R.Y.G.B.W	AL70-RYGBW-31Z4
有蜂鸣器 With buzzer	
1节红色 1Layer red	AL70-RM-23Z4
2节红.绿 2Layer R.G	AL70-RGM-23Z4
3节红.黄.绿 3Layer R.Y.G	AL70-RYGM-23Z4
AC/DC 24V	
4节红.黄.绿.蓝 4Layer R.Y.G.B	AL70-RYGBM-23Z4
5节红.黄.绿.蓝.白 5Layer R.Y.G.B.W	AL70-RYGBWM-23Z4

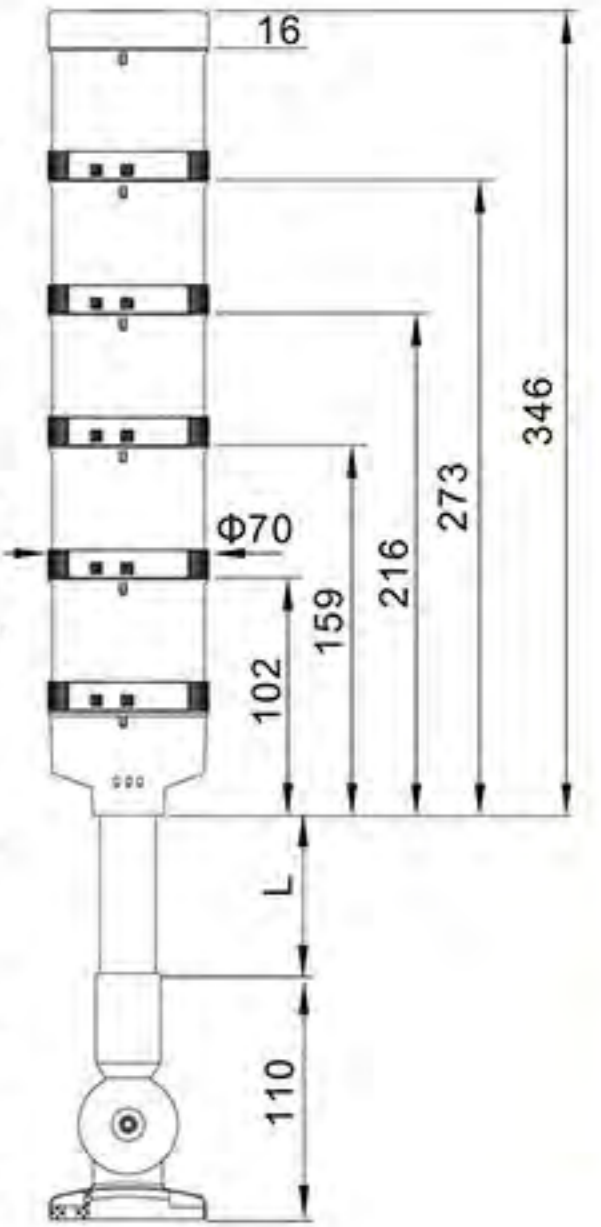

AL70系列



侧装座
Side mounting base

1节红色 1Layer red	AL70-R-31C5
无蜂鸣器 Without buzzer	
2节红.绿 2Layer R.G	AL70-RG-31C5
3节红.黄.绿 3Layer R.Y.G	AL70-RYG-31C5
AC 220V	
4节红.黄.绿.蓝 4Layer R.Y.G.B	AL70-RYGB-31C5
5节红.黄.绿.蓝.白 5Layer R.Y.G.B.W	AL70-RYGBW-31C5
有蜂鸣器 With buzzer	
1节红色 1Layer red	AL70-RM-23C5
2节红.绿 2Layer R.G	AL70-RGM-23C5
3节红.黄.绿 3Layer R.Y.G	AL70-RYGM-23C5
AC/DC 24V	
4节红.黄.绿.蓝 4Layer R.Y.G.B	AL70-RYGBM-23C5
5节红.黄.绿.蓝.白 5Layer R.Y.G.B.W	AL70-RYGBWM-23C5

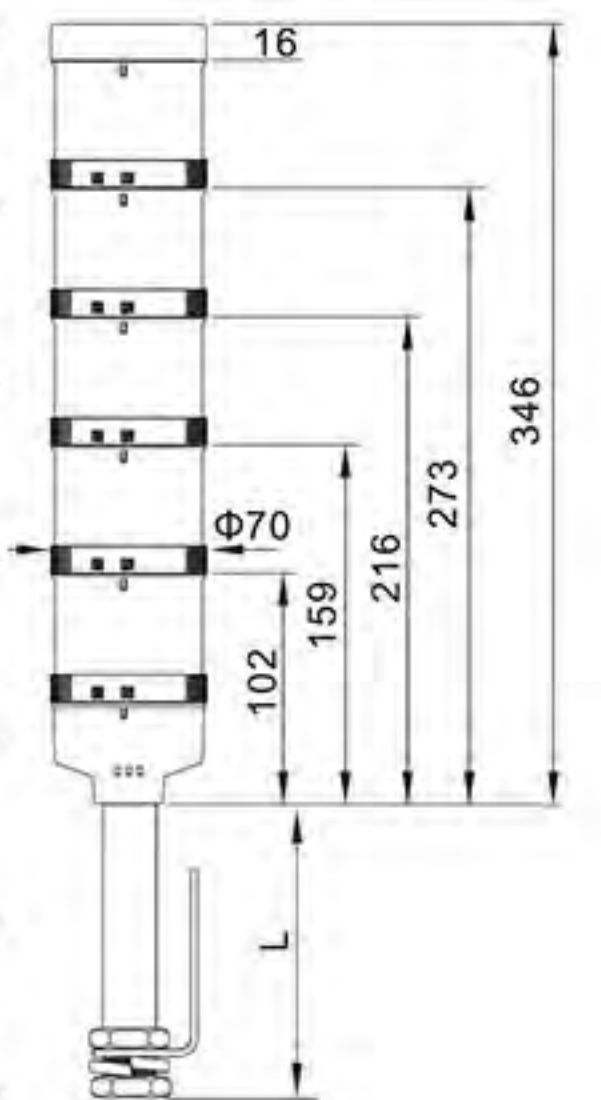

注：出厂默认配置为发光单元“红灯、黄灯”闪亮，“绿灯、蓝灯、白灯”常亮；“蜂鸣器”间断响；壳体分黑色和白色两种，不同型号默认颜色不同，如有要求请在下单时另行注明。

样式 Product style	描述 Product description	型号 Model	尺寸 Contour
AL801系列  平装座 Paperback base	红色 (无蜂鸣器) Red (Without buzzer) AC220V	AL801-R-31	 128 42 Φ83
	红色 (带蜂鸣器) Red (With buzzer) AC220V	AL801-RM-31	
	多色 (无蜂鸣器) Multicolor (Without buzzer) AC/DC 24V	AL801-RGB-23	
	多色 (带蜂鸣器) Multicolor (With buzzer) AC/DC 24V	AL801-RGBM-23	
AL901系列  平装座 Paperback base	红色 (无蜂鸣器) Red (Without buzzer) AC220V	AL901-R-31	 137 27 Φ96
	红色 (带蜂鸣器) Red (With buzzer) AC220V	AL901-RM-31	
	多色 (无蜂鸣器) Multicolor (Without buzzer) AC/DC 24V	AL901-RGB-23	
	多色 (带蜂鸣器) Multicolor (With buzzer) AC/DC 24V	AL901-RGBM-23	
AL901系列  侧装座 Side mounting base 竖装座 Vertical base	圆头红色 (无蜂鸣器) Round head red (Without buzzer) AC220V	竖装座 Vertical base AL901-R-31P4	 137 27 Φ96 55
	圆头红色 (带蜂鸣器) Round head red (With buzzer) AC220V	折叠座 Collapsible Universal base AL901-R-31Z4	
	圆头红色 (带蜂鸣器) Round head red (With buzzer) AC220V	侧装座 Side mounting base AL901-R-31C5	
	圆头红色 (带蜂鸣器) Round head red (With buzzer) AC220V	竖装座 Vertical base AL901-RM-31P4	
	圆头红色 (带蜂鸣器) Round head red (With buzzer) AC220V	折叠座 Collapsible Universal base AL901-RM-31Z4	
	圆头红色 (带蜂鸣器) Round head red (With buzzer) AC220V	侧装座 Side mounting base AL901-RM-31C5	
	圆头多色 (无蜂鸣器) Round head multicolor (Without buzzer) AC/DC 24V	竖装座 Vertical base AL901-RGB-23P4	 137 27 Φ96
	圆头多色 (无蜂鸣器) Round head multicolor (Without buzzer) AC/DC 24V	折叠座 Collapsible Universal base AL901-RGB-23Z2	
	圆头多色 (无蜂鸣器) Round head multicolor (Without buzzer) AC/DC 24V	侧装座 Side mounting base AL901-RGB-23C5	
	圆头多色 (带蜂鸣器) Round head multicolor (With buzzer) AC/DC 24V	竖装座 Vertical base AL901-RGBM-23P2	
	圆头多色 (带蜂鸣器) Round head multicolor (With buzzer) AC/DC 24V	折叠座 Collapsible Universal base AL901-RGBM-23Z2	
	圆头多色 (带蜂鸣器) Round head multicolor (With buzzer) AC/DC 24V	侧装座 Side mounting base AL901-RGBM-23C5	

注：出厂默认配置为发光单元“红灯、黄灯”闪亮，“绿灯、蓝灯、白灯”常亮；“蜂鸣器”间断响；壳体分黑色和白色两种，不同型号默认颜色不同，如有要求请在下单时另行注明。

样式 Product style	型号 Model	样式 Product style	型号 Model
	AL50-G-31D		AL50-SZ
	AL70-R-31D		AL70-SZ
	AL70-CZ		AL50-CZ-1
	AL701-CZ		AL70-CZ-1
	AL901-CZ		AL50-CZ-Z
	AL50-ZZ		AL70-CZ-Z
	AL70-ZZ		
	AL50-P1 (87mm)		AL70-P1 (58mm)
			AL70-P2 (88mm)
			AL70-P3 (118mm)
	AL50-P2 (142mm)		AL70-P4 (168mm)
	AL50-P3 (242mm)		AL70-P5 (218mm)
			AL70-P6 (268mm)
			AL70-P7 (318mm)
	AL50-C3 (242mm)		AL70-C5 (218mm)

注：出厂默认配置为发光单元“红灯、黄灯”闪亮，“绿灯、蓝灯、白灯”常亮；“蜂鸣器”间断响；壳体分黑色和白色两种，不同型号默认颜色不同，如有要求请在下单时另行注明。

AL-LED警示灯系列
AL-LED warning lamp series

AL-LED警示灯系列
AL-LED warning lamp series

型号及含义 TYPE AND MEANING

LA115 - □ □ 1 2 3 / 4 5 6

头部类型 (1为塑料头部系列、2为金属头部系列、5为喷漆头部系列)
Operators (1-Plastic Bezel type, 2-Metal bezel type, 5-Paint spraying)
设计序号 Design serial number

按钮开关型号 (由上海电器科学研究所批准发放, 浙江高桥电子有限公司专用)
Push button code (Issued by Shanghai Electrical Apparatus Research Institute, only used by Zhejiang Gaoqiao Electronic Co., Ltd)

1 表示常开触头 NO contact

2 表示常闭触头 NC contact

4 表示颜色及旋钮钥匙钮动作功能和拔出位置
Color, selector button and keylock button operation function and pulling out position

红	绿	黄	蓝	白	黑
R	G	Y	B	W	K

动作功能 spring return action

f	fu	ffu
左自复 left to centre	右自复 right to centre	左右自复 Left-right to centre

5 电压(Voltage)

21-DC.AC 6V	26-DC.AC 110V
22-DC.AC 12V	27-DC.AC 127V
23-DC.AC 24V	28-DC 220V
24-DC.AC 36V	31-AC 220V
25-DC.AC 48V	32-AC 380V

6 标志钮符号代码 (Code of push button symbol)

1	2	3	4	5	6
7	8	9	10	11	12

使用环境条件 WORKING ENVIRONMENT

周围空气温度 -25℃ ~ +40℃; Ambient air temperature -25℃ ~ +40℃.
海拔高度 ≤ 2000m; Altitude: ≤ 2000m.
空气相对湿度 ≤ 90%; Relative air humidity: ≤ 90%.
污染等级 3级; Pollution degree: class 3.
防护等级 IP40/IP65; Protection degree: IP40/IP65.

主要技术参数 MAIN TECHNICAL PARAMETER

开关额定值 Rated value of switch: AC-15 36V/10A 110V/10A 220V/5A 380V/2.7A 660V/1.8A
DC-13 24V/4A 48V/4A 110V/2A 220V/1A 440V/0.6A.

约定发热电流 Conventional thermal current: Ith 10A.

触点电阻 Contact resistance: ≤ 50mΩ

绝缘电阻 Insulation resistance: ≥ 10MΩ

机械寿命 Mechanical durability: 一般按钮 Common push-button ≥ 100 × 10⁴次 times; 旋钮 Selector button ≥ 30 × 10⁴次 times.
钥匙按钮 Key push-button ≥ 5 × 10⁴次 times; 紧急按钮 Emergency push-button ≥ 5 × 10⁴次 times.

3 表示机械形式 Mechanical form

字母 letter	含义 Implication
	平钮 Flush push button
D	带灯钮 Illuminated push button
T	自锁钮 Maintained push button
TD	带灯自锁钮 Illuminated Maintained push button
M	蘑菇钮 Mushroom push button
MD	带灯蘑菇钮 Illuminated Mushroom button
MT	自锁蘑菇钮 Maintained Mushroom button
MTD	带灯自锁蘑菇钮 Illuminated Maintained Mushroom button
ZS	急停钮 Emergency stop button
Y	二位钥匙钮 2-Position keylock selector
YS	三位钥匙钮 3-Position keylock selector
X	短柄二档旋钮 2-Position short lever selector
XD	带灯短柄二档旋钮 Illuminated 2-Position short lever selector
XS	短柄三档旋钮 3-Position short lever selector
XSD	带灯短柄三档旋钮 Illuminated 3-Position short lever selector
CX	长柄二档旋钮 2-Position long lever selector
CXD	带灯长柄二档旋钮 Illuminated 2-Position long lever selector
CXS	长柄三档旋钮 3-Position long lever selector
CXSD	带灯长柄三档旋钮 Illuminated 3-Position long lever selector
R	双位钮 Dual push button
RD	带灯双位钮 Illuminated dual push button
H	高位钮 Extended push button
HD	带灯高位钮 Illuminated extended push button
HT	自锁高位钮 Maintained extended push button
HTD	带灯自锁高位钮 Illuminated Maintained extended push button
HF	高平钮 Higher flush button
B	平钮带符号 Flush button marked
E	Ø30平钮(适用于Ø22-Ø30孔径) Flush button (Suitable for Ø22 to Ø30 mounting hole)

描述 Description

尺寸 Contour

描述 Description

尺寸 Contour



自复型 Momentary
LA115-A5-10

自锁型 Maintained
LA115-A5-10T

带灯自复型 Momentary Illuminated
LA115-A5-10D

带灯自锁型 Maintained Illuminated
LA115-A5-10TD



自复型 Momentary
LA115-A5-10B

自锁型 Maintained
LA115-A5-10TB

带灯自复型 Momentary Illuminated
LA115-A5-10BD

带灯自锁型 Maintained Illuminated
LA115-A5-10BTD



自复型 Momentary
LA115-A5-10H

自锁型 Maintained
LA115-A5-10HT

带灯自复型 Momentary Illuminated
LA115-A5-10HD

带灯自锁型 Maintained Illuminated
LA115-A5-10HTD



自复型 Momentary
LA115-A5-10HF

自锁型 Maintained
LA115-A5-10HFT

带灯自复型 Momentary Illuminated
LA115-A5-10HFD

带灯自锁型 Maintained Illuminated
LA115-A5-10HFTD

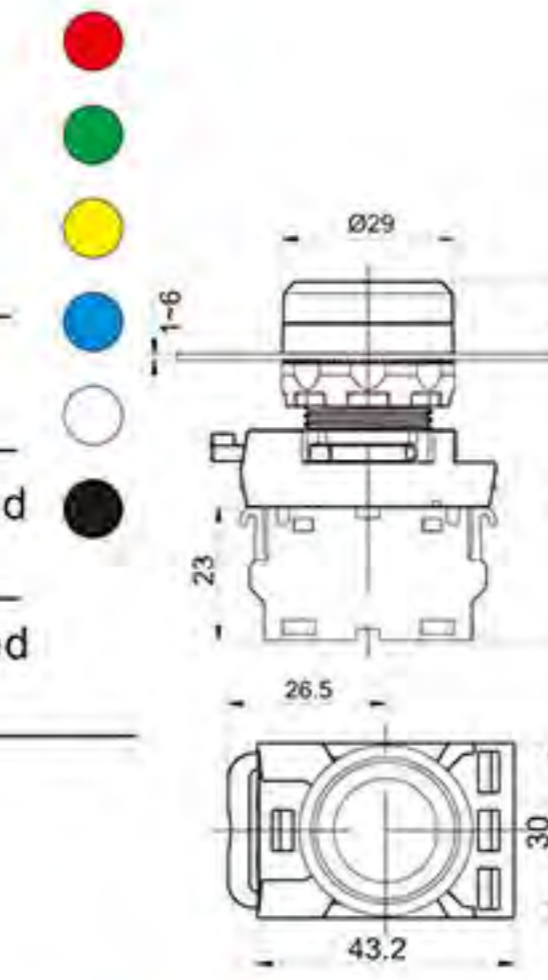

- 1 1 2 2
- 3 3 4 4
- 5 5 6 6
- 7 7 8 8
- 9 9 10 10
- 11 11 12 12



自复型 Momentary
LA115-A5-10M

自锁型 Maintained
LA115-A5-10MT

带灯自复型 Momentary Illuminated
LA115-A5-10MD

带灯自锁型 Maintained Illuminated
LA115-A5-10MTD



两档自锁型 Maintained 2-Position
LA115-A5-10X

两档自复型 Momentary 2-Position
LA115-A5-10X/FU



带灯自锁型 Maintained Illuminated
2-Position
LA115-A5-10XD

带灯自复型 Momentary Illuminated
2-Position
LA115-A5-10XD/FU



三档自锁型 Maintained 3-Position
LA115-A5-11XS

三档自复型 Momentary 3-Position
LA115-A5-11XS/FU



带灯自锁型 Maintained Illuminated
LA115-A5-11XSD

带灯自复型 Momentary Illuminated
LA115-A5-11XSD/FU

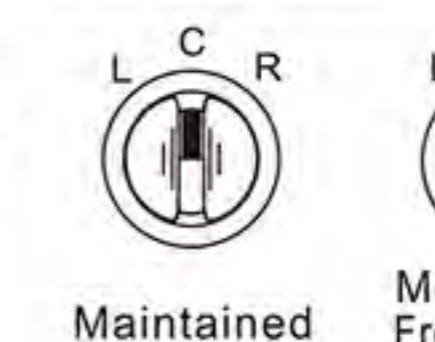

Maintained 自锁
Momentary From R to C 由右至中和
Momentary From L to C 由左至中自复
Momentary From R to C 由右至中自复

LA115-A/B按钮系列
LA115-A/B push button series

描述 Description	尺寸 Contour	描述 Description	尺寸 Contour
<p>两档自锁型 Maintained 2-Position LA115-A5-10Y</p> <p>两档自复型 Momentary 2-Position LA115-A5-10Y/FU</p>		<p>不带灯自复型 Momentary Non-illuminated LA115-A5-11R1</p> <p>带灯自复型 Momentary Illuminated LA115-A5-11RD1</p>	<p>R </p> <p>R1 </p> <p>R2 </p> <p>R3 </p> <p>R4 </p> <p>R5 </p> <p>R6 </p> <p>R7 </p>
<p>三档自锁型 Maintained 3-Position LA115-A5-11YS</p> <p>三档自复型 Momentary 3-Position LA115-A5-11YS/FU</p>		<p>自复型 Momentary LA115-A5-10E</p> <p>自锁型 Maintained LA115-A5-10ET</p> <p>带灯自复型 Momentary Illuminated LA115-A5-10ED</p> <p>带灯自锁型 Maintained Illuminated LA115-A5-10ETD</p>	<p>Ø22~Ø30</p>
<p>旋转或拉拔释放 Twist Release 不带灯型 Pull Release Non-illuminated LA115-A5-11ZT</p> <p>旋转或拉拔释放 Twist Release 带灯型 Pull Release Illuminated LA115-A5-11ZF</p>		<p>自复型 Momentary LA115-A5-10EB</p> <p>自锁型 Maintained LA115-A5-10EBT</p> <p>带灯自复型 Momentary Illuminated LA115-A5-10EBD</p> <p>带灯自锁型 Maintained Illuminated LA115-A5-10EBTD</p>	<p>Ø22~Ø30</p>
<p>旋转释放 Twist Release 不带灯型 Non-illuminated LA115-A5-01ZS</p>		<p>自复型 Momentary LA115-A5-10EH</p> <p>自锁型 Maintained LA115-A5-10EHT</p> <p>带灯自复型 Momentary Illuminated LA115-A5-10EHD</p> <p>带灯自锁型 Maintained Illuminated LA115-A5-10EHTD</p>	<p>Ø22~Ø30</p>

描述 Description	尺寸 Contour	描述 Description	尺寸 Contour
<p>自锁型 Momentary 二档旋钮 2-Position LA115-A5-10EX</p> <p>自锁型 Maintained 三档旋钮 3-Position LA115-A5-10EXS/FU</p>		<p>自复型 Momentary LA115-A5-10EM</p> <p>自锁型 Maintained LA115-A5-10EMT</p> <p>带灯自复型 Momentary Illuminated LA115-A5-10EMD</p> <p>带灯自锁型 Maintained Illuminated LA115-A5-10EMTD</p>	<p>Ø22~Ø30</p>
<p>自复型 Momentary LA115-B5-10</p> <p>自锁型 Maintained LA115-B5-10T</p> <p>带灯自复型 Momentary Illuminated LA115-B5-10D</p> <p>带灯自锁型 Maintained Illuminated LA115-B5-10TD</p>		<p>自复型 Momentary LA115-B5-10HF</p> <p>自锁型 Maintained LA115-B5-10HFT</p> <p>带灯自复型 Momentary Illuminated LA115-B5-10HFD</p> <p>带灯自锁型 Maintained Illuminated LA115-B5-10HFTD</p>	<p>Ø29</p>
<p>自复型 Momentary LA115-B5-10B</p> <p>自锁型 Maintained LA115-B5-10BT</p> <p>带灯自复型 Momentary Illuminated LA115-B5-10BD</p> <p>带灯自锁型 Maintained Illuminated LA115-B5-10BTD</p>		<p>自复型 Momentary LA115-B5-10M</p> <p>自锁型 Maintained LA115-B5-10MT</p> <p>带灯自复型 Momentary Illuminated LA115-B5-10MD</p> <p>带灯自锁型 Maintained Illuminated LA115-B5-10MTD</p>	<p>Ø29</p>
<p>自复型 Momentary LA115-B5-10H</p> <p>自锁型 Maintained LA115-B5-10HT</p> <p>带灯自复型 Momentary Illuminated LA115-B5-10HD</p> <p>带灯自锁型 Maintained Illuminated LA115-B5-10HTD</p>		<p>两档自锁型 Maintained 2-Position LA115-B5-10X</p> <p>两档自复型 Momentary 2-Position LA115-B5-10X/FU</p> <p>带灯自锁型 Maintained Illuminated 2-Position LA115-B5-10XD</p> <p>带灯自复型 Momentary Illuminated 2-Position LA115-B5-10XD/FU</p>	<p>Ø29</p>

LA115-A/B按钮系列
LA115-A/B push button series











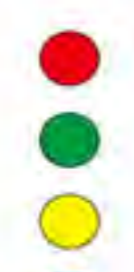





LA115-A/B按钮系列
LA115-A/B push button series











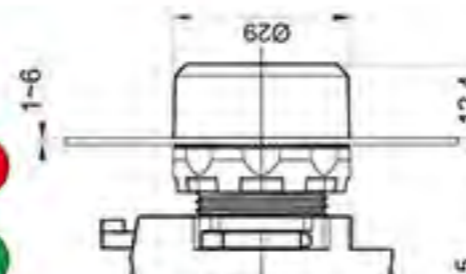

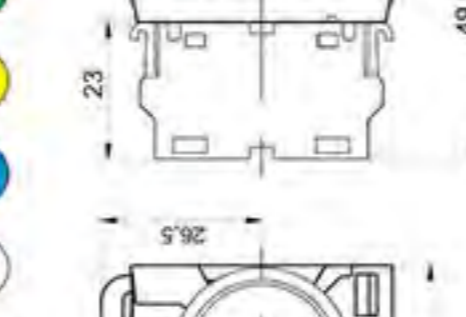

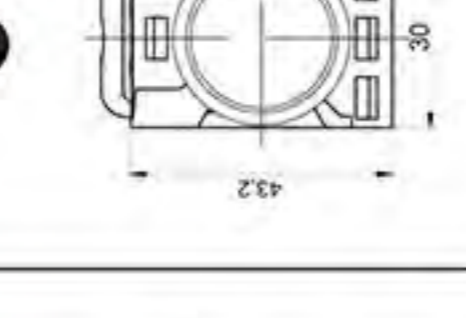

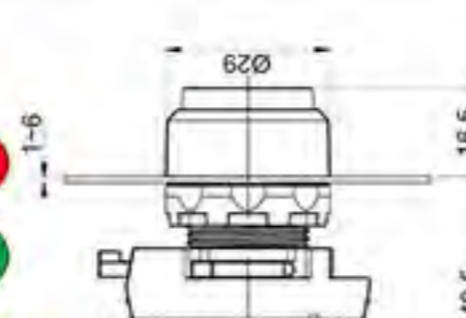

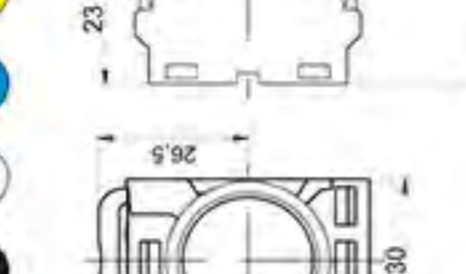

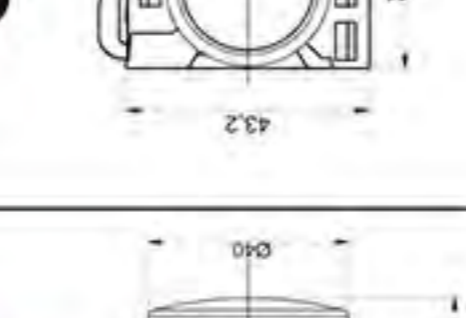

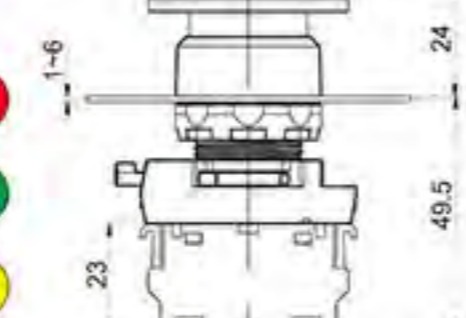

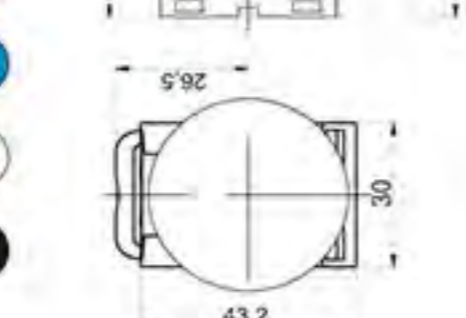

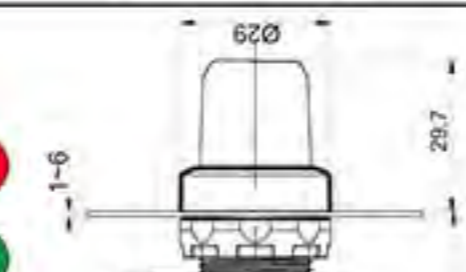
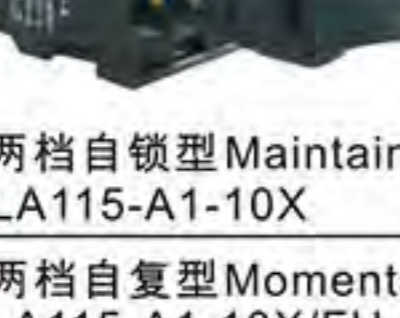
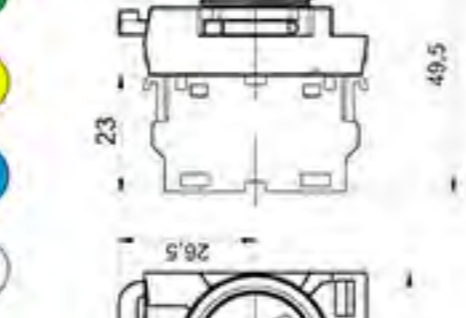
描述 Description	尺寸 Contour	描述 Description	尺寸 Contour
两档自锁型 Maintained 2-Position LA115-B5-10Y 两档自复型 Momentary 2-Position LA115-B5-10Y/FU		旋转释放 Twist Release 不带灯型 Non-illuminated LA115-B5-01ZS	
三档自锁型 Maintained 3-Position LA115-B5-11YS 三档自复型 Momentary 3-Position LA115-B5-11YS/FU		自复型 Momentary LA115-B5-10E 自锁型 Maintained LA115-B5-10ET 带灯自复型 Momentary Illuminated LA115-B5-10ED 带灯自锁型 Maintained Illuminated LA115-B5-10ETD	
旋转或拉拔释放 Twist Release 不带灯型 Pull Release Non-illuminated LA115-B5-11ZT		自复型 Momentary LA115-B5-10EB 自锁型 Maintained LA115-B5-10EBT 带灯自复型 Momentary Illuminated LA115-B5-10EBD 带灯自锁型 Maintained Illuminated LA115-B5-10EBTD	
旋转或拉拔释放 Twist Release 带灯型 Pull Release illuminated LA115-B5-11ZF		自复型 Momentary LA115-B5-10EH 自锁型 Maintained LA115-B5-10EHT 带灯自复型 Momentary Illuminated LA115-B5-10EHD 带灯自锁型 Maintained Illuminated LA115-B5-10EHTD	
不带灯自复型 Momentary Non-illuminated LA115-B5-11R1 带灯自复型 Momentary Illuminated LA115-B5-11RD1	 		

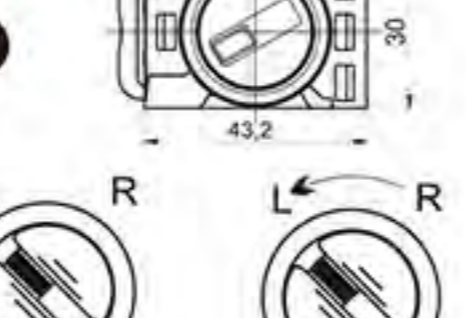

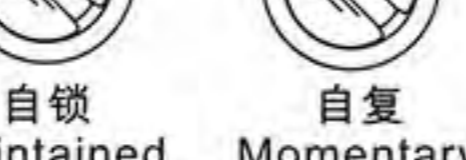

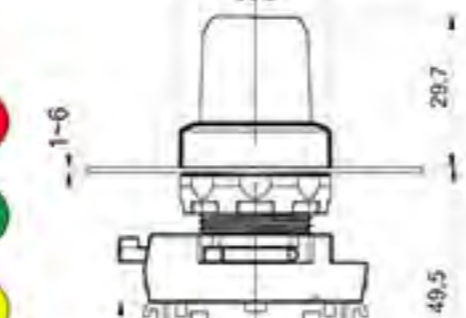

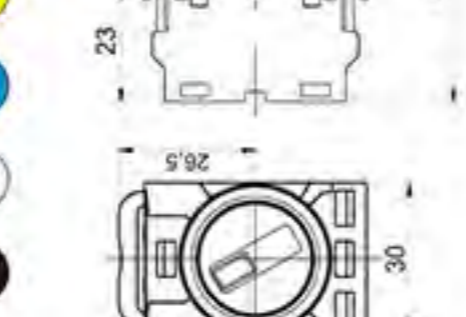

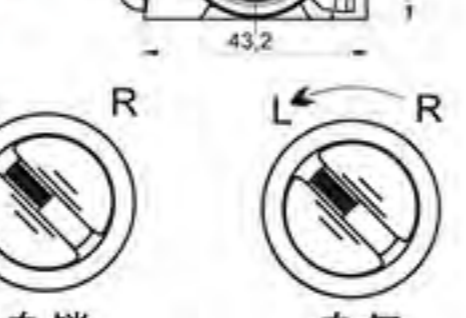
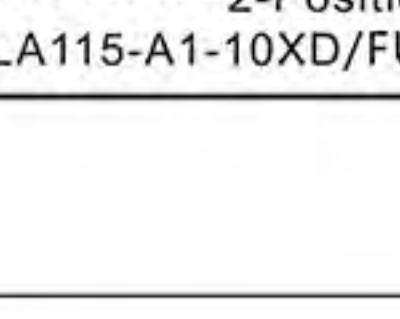
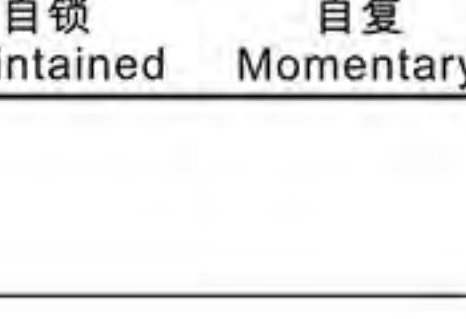

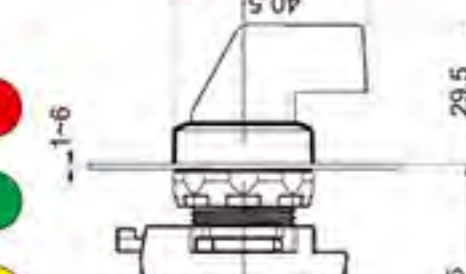
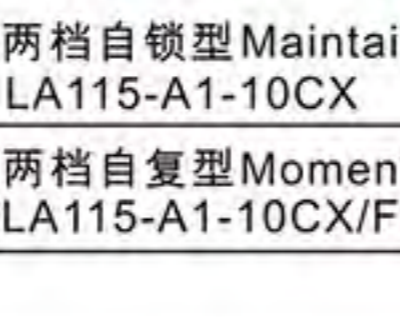
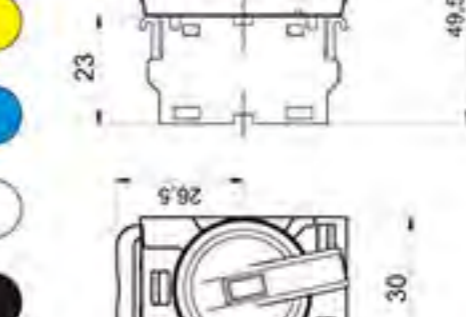
描述 Description	尺寸 Contour	描述 Description	尺寸 Contour
两档自锁型 Maintained 2-Position LA115-B5-10EX 两档自复型 Momentary 2-Position LA115-B5-10EX/FU		自复型 Momentary LA115-B5-10EM 自锁型 Maintained LA115-B5-10EMT 带灯自复型 Momentary Illuminated LA115-B5-10EMD 带灯自锁型 Maintained Illuminated LA115-B5-10EMTD	
Flush Button LA115-5-BN Momentary 平钮头部 (自复)		Flush Button Maked LA115-5-B/7 Momentary 平钮头部 (自复)	
Flush Button Illuminated LA115-5-D Momentary 平钮头部 (带灯自复)		Flush Button Maked Illuminated LA115-5-B/7 Momentary 平钮头部 (带灯自复)	
Extended Button LA115-5-H Momentary 凸钮头部 (自复)		Short Handle Selector LA115-5-XS/FU Momentary Two-Positon 两/三档自复旋钮	
Extended Button Illuminated LA115-5-HD Momentary 凸钮头部 (带灯自复)		Short Handle Selector Illuminated LA115-5-XS Maintained Two-Positon 两/三档自锁旋钮	
Mushroom Button LA115-5-M Momentary 蘑菇钮头部 (自复)		Short Handle Selector LA115-5-XS Maintained Two-Positon 两/三档自锁旋钮	
Mushroom Button Illuminated LA115-5-MD Momentary 蘑菇钮头部 (带灯自复)		key-operated Selector LA115-5-YS/FU Momentary 2/3-Positon 两/三档自复型	

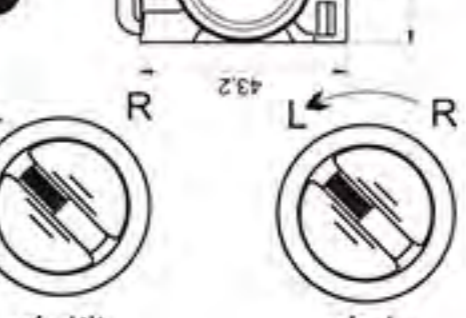
LA115-A/B按钮系列
LA115-A/B push button series

LA115-A/B按钮系列
LA115-A/B push button series

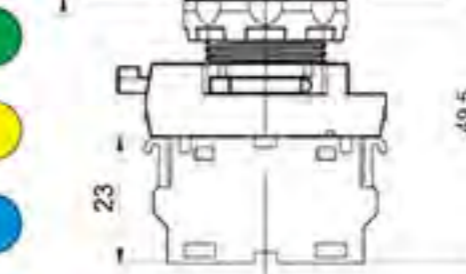
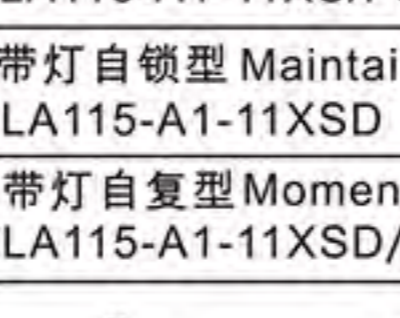
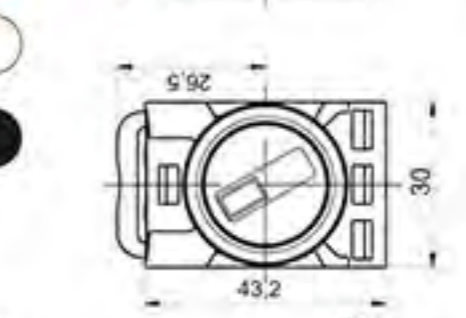
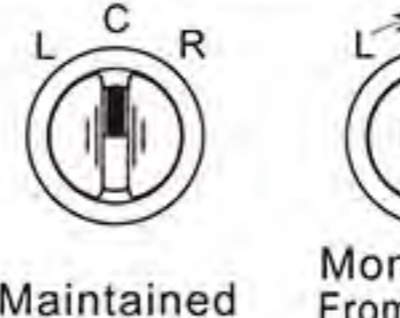
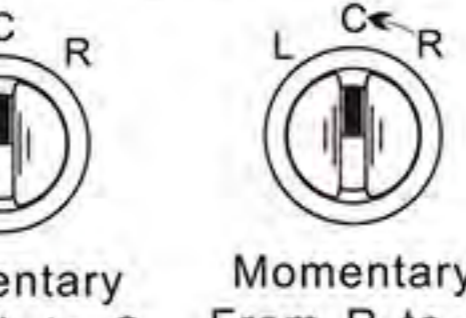
描述 Description	尺寸 Contour
 LA115-5-HF Momentary 高平钮头部 (自复) LA115-5-HFT Maintained 高平钮头部 (自锁)	
 LA115-5-HFD Momentary 高平钮头部 (带灯自复) LA115-5-HFTD Maintained 高平钮头部 (带灯自锁)	
 LA115-5-RD LA115-5-RD1 LA115-5-RD2 LA115-5-RD3 LA115-5-RD4 LA115-5-RD5 LA115-5-RD6 LA115-5-RD7	
 LA115-5-ZT Twist Release Pull Release Non-illuminated 旋转或者拉拔释放 不带灯型	
 LA115-5-ZF Twist Release Pull Release Illuminated 旋转或者拉拔释放 带灯型	
 LA115-5-E Momentary 平钮头部 (自复) LA115-5-ET Maintained 平钮头部 (自锁)	
 LA115-5-ED Momentary 平钮头部 (自复) LA115-5-ETD Maintained 平钮头部 (自锁)	
 LA115-5-EH Momentary 凸钮头部 (自复) LA115-5-EHT Maintained 凸钮头部 (自锁)	
 LA115-5-EHD/Y Momentary 凸钮头部 (带灯自复) LA115-5-EHTD/Y Maintained 凸钮头部 (带灯自锁)	

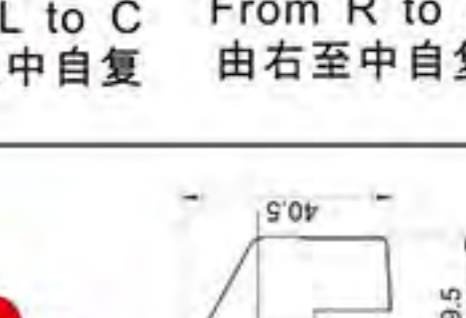
描述 Description	尺寸 Contour
 自复型 Momentary LA115-A1-10	
 自锁型 Maintained LA115-A1-10T	
 带灯自复型 Momentary Illuminated LA115-A1-10D	
 带灯自锁型 Maintained Illuminated LA115-A1-10TD	
 自复型 Momentary LA115-A1-10H	
 自锁型 Maintained LA115-A1-10HT	
 带灯自复型 Momentary Illuminated LA115-A1-10HD	
 带灯自锁型 Maintained Illuminated LA115-A1-10HTD	
 自复型 Momentary LA115-A1-10M	
 自锁型 Maintained LA115-A1-10MT	
 带灯自复型 Momentary Illuminated LA115-A1-10MD	
 带灯自锁型 Maintained Illuminated LA115-A1-10MTD	
 两档自锁型 Maintained 2-Position LA115-A1-10X	
 两档自复型 Momentary 2-Position LA115-A1-10X/FU	
 带灯自锁型 Maintained Illuminated 2-Position LA115-A1-10XD	
 带灯自复型 Momentary Illuminated 2-Position LA115-A1-10XD/FU	

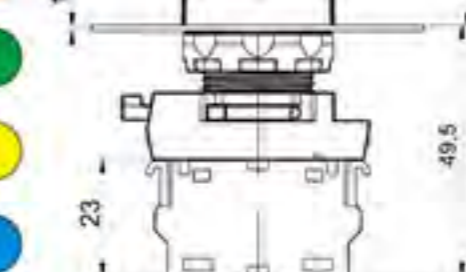
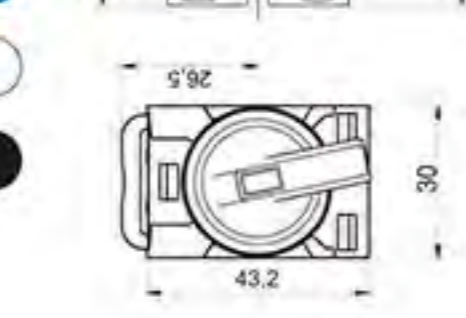
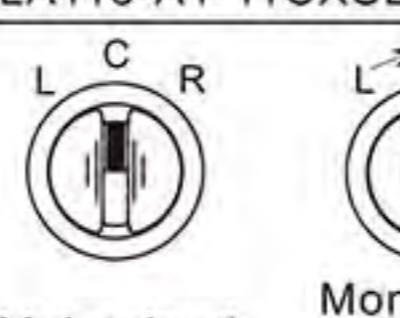
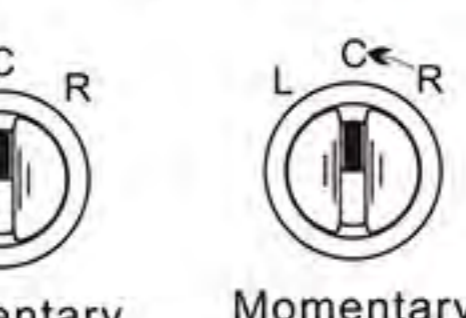
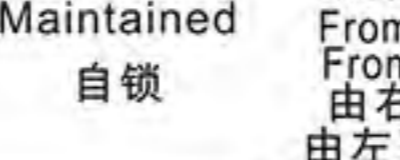
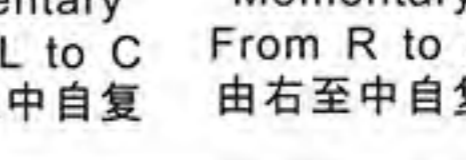
描述 Description	尺寸 Contour
 两档自锁型 Maintained 2-Position LA115-A1-10CX	
 两档自复型 Momentary 2-Position LA115-A1-10CX/FU	
 带灯自锁型 Maintained Illuminated 2-Position LA115-A5-10CXD	
 带灯自复型 Momentary Illuminated 2-Position LA115-A5-10CXD/FU	
 三档自锁型 Maintained 3-Position LA115-A1-11XS	
 三档自复型 Momentary 3-Position LA115-A1-11XS/FU	
 带灯自锁型 Maintained Illuminated 3-Position LA115-A1-11XSD	
 带灯自复型 Momentary Illuminated 3-Position LA115-A1-11XSD/FU	
 三档自锁型 Maintained 3-Position LA115-A1-11CX	
 三档自复型 Momentary 3-Position LA115-A1-11CX/FU	
 带灯自锁型 Maintained Illuminated 3-Position LA115-A1-11CXSD	
 带灯自复型 Momentary Illuminated 3-Position LA115-A1-11CXSD/FU	

描述 Description	尺寸 Contour
 两档自锁型 Maintained 2-Position LA115-A1-10Y	
 两档自复型 Momentary 2-Position LA115-A1-10Y/FU	
 三档自锁型 Maintained 3-Position LA115-A1-11YS	
 三档自复型 Momentary 3-Position LA115-A1-11YS/FU	
 旋转释放 Twist Release 不带灯型 Non-illuminated LA115-A1-01ZS	
 BA9S 灯座 BA9S base LA115-A1-D/▲	
 一体式LED灯座 Integrated lamp block LA115-A1-D1/▲	
 不带灯自复型 Momentary Non-illuminated LA115-A1-11R1	
 带灯自复型 Momentary Illuminated LA115-A1-11RD1	

LA115-A/B按钮系列
LA115-A/B push button series









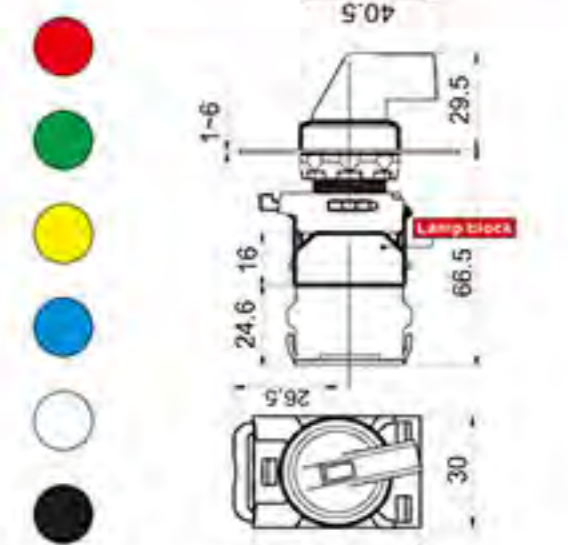

LA115-A/B按钮系列
LA115-A/B push button series

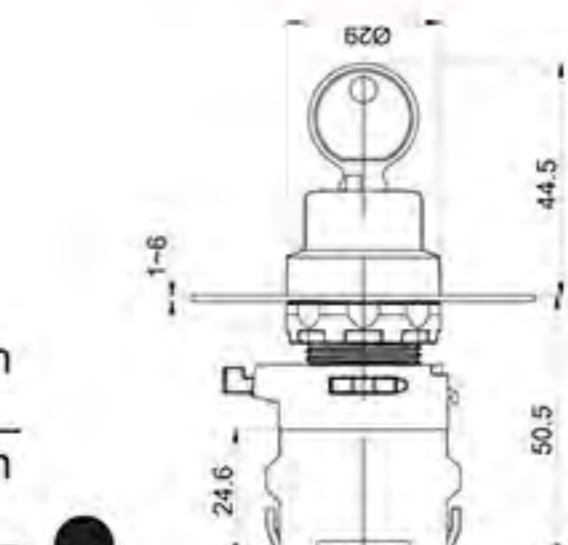

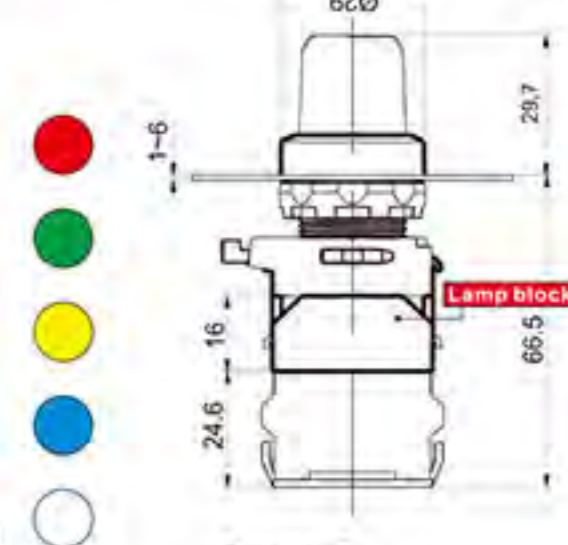

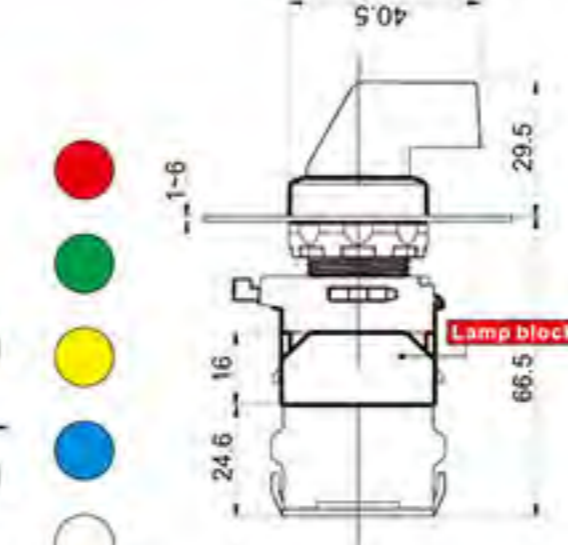
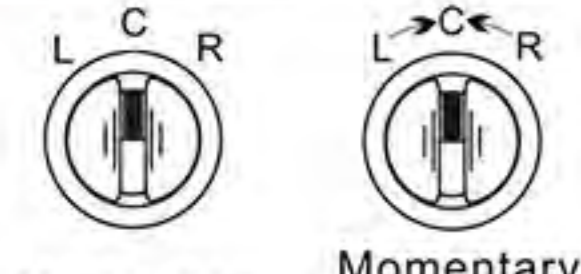
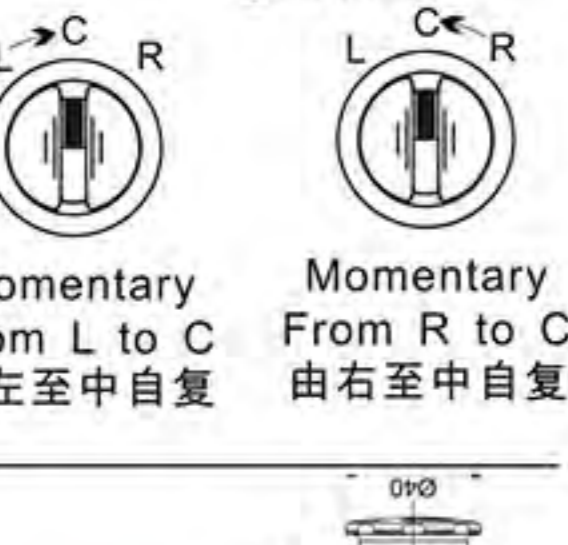
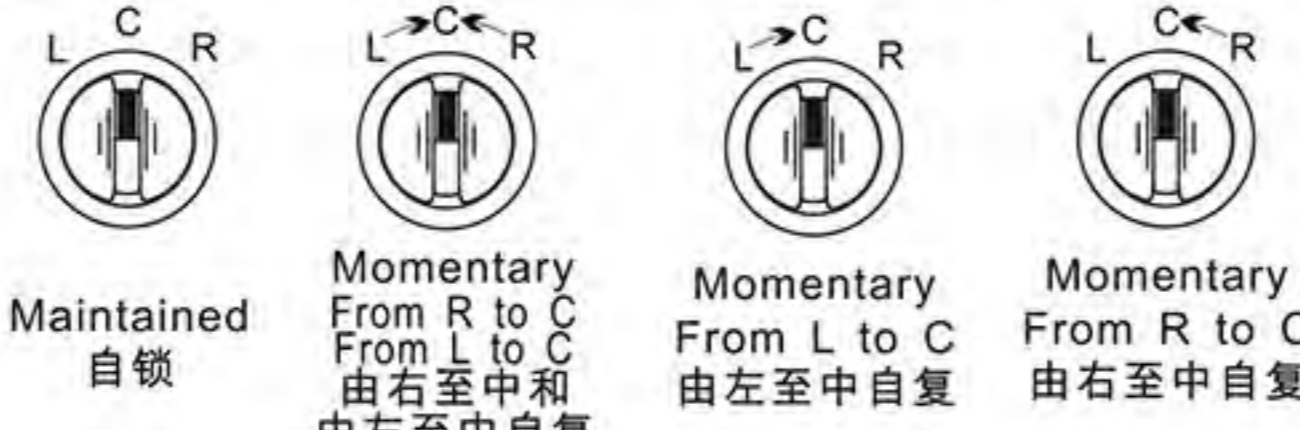

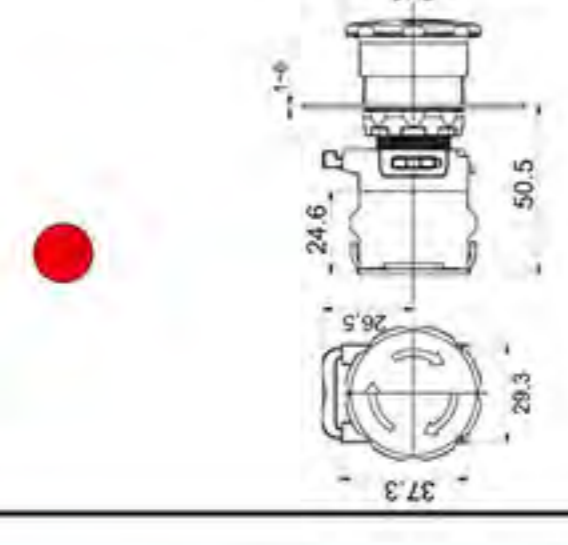

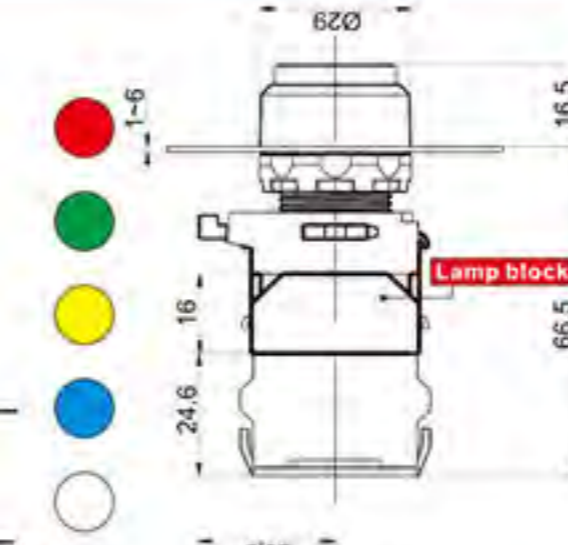

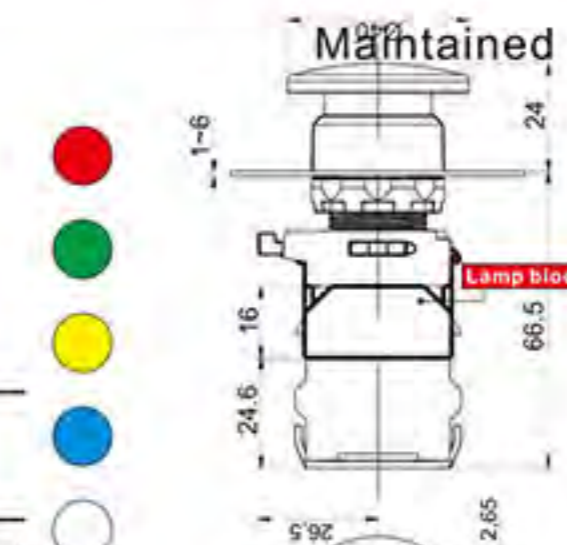

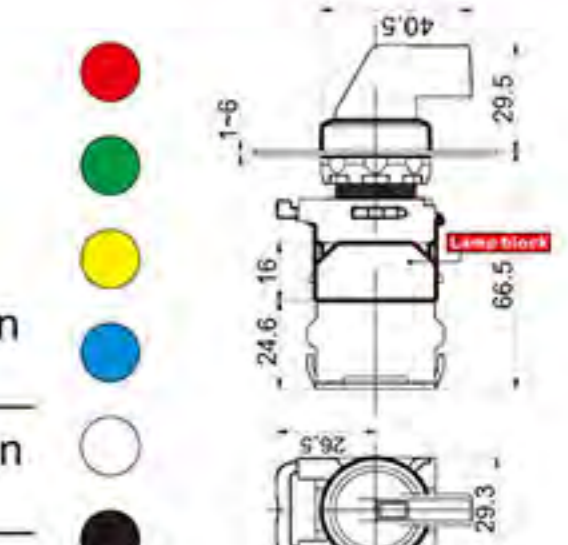
描述 Description	尺寸 Contour	描述 Description	尺寸 Contour
自复型 Momentary LA115-A2-10 自锁型 Maintained LA115-A2-10T 带灯自复型 Momentary Illuminated LA115-A2-10D 带灯自锁型 Maintained Illuminated LA115-A2-10TD		两档自锁型 Maintained 2-Position LA115-A2-10CX 两档自复型 Momentary 2-Position LA115-A2-10CX/FU 带灯自锁型 Maintained Illuminated 2-Position LA115-A2-10CXD 带灯自复型 Momentary Illuminated 2-Position LA115-A2-10CXD/FU	
自复型 Momentary LA115-A2-10H 自锁型 Maintained LA115-A2-10HT 带灯自复型 Momentary Illuminated LA115-A2-10HD 带灯自锁型 Maintained Illuminated LA115-A2-10HTD		三档自锁型 Maintained 3-Position LA115-A2-11XS 三档自复型 Momentary 3-Position LA115-A2-11XS/FU 带灯自锁型 Maintained Illuminated LA115-A2-11XSD 带灯自复型 Momentary Illuminated LA115-A2-11XSD/FU	
自复型 Momentary LA115-A2-10M 自锁型 Maintained LA115-A2-10MT 带灯自复型 Momentary Illuminated LA115-A2-10MD 带灯自锁型 Maintained Illuminated LA115-A2-10MTD		三档自锁型 Maintained 3-Position LA115-A2-11CXS 三档自复型 Momentary 3-Position LA115-A2-11CXS/FU 带灯自锁型 Maintained Illuminated LA115-A2-11CXSD 带灯自复型 Momentary Illuminated LA115-A2-11CXSD/FU	
两档自锁型 Maintained 2-Position LA115-A2-10X 两档自复型 Momentary 2-Position LA115-A2-10X/FU 带灯自锁型 Maintained Illuminated 2-Position LA115-A2-10XD 带灯自复型 Momentary Illuminated 2-Position LA115-A2-10XD/FU		带灯自锁型 Maintained Illuminated 2-Position LA115-A2-11CXS 带灯自复型 Momentary Illuminated 2-Position LA115-A2-11CXS/FU	

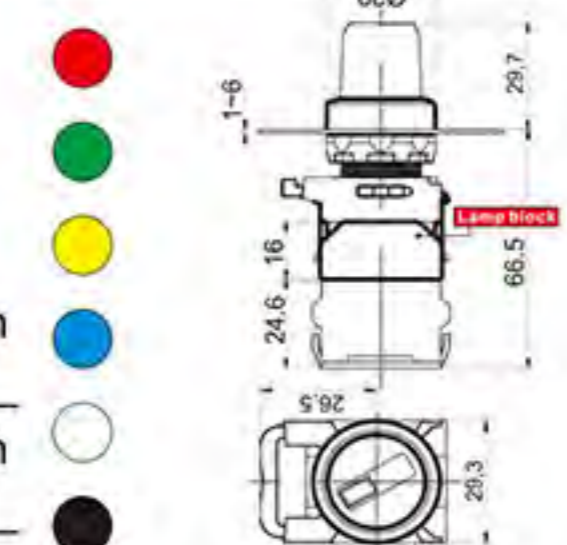
描述 Description	尺寸 Contour	描述 Description	尺寸 Contour
两档自锁型 Maintained 2-Position LA115-A2-10Y 两档自复型 Momentary 2-Position LA115-A2-10Y/FU 三档自锁型 Maintained 3-Position LA115-A2-11YS 三档自复型 Momentary 3-Position LA115-A2-11YS/FU		旋转释放 Twist Release 不带灯型 Non-illuminated LA115-A2-01ZS	
自复型 Momentary LA115-B1-10 自锁型 Maintained LA115-B1-10T 带灯自复型 Momentary Illuminated LA115-B1-10D 带灯自锁型 Maintained Illuminated LA115-B1-10TD		不带灯自复型 Momentary Non-illuminated LA115-B3-11R1 带灯自复型 Momentary Illuminated LA115-B3-11RD1	
自复型 Momentary LA115-B1-10M 自锁型 Maintained LA115-B1-10MT 带灯自复型 Momentary Illuminated LA115-B1-10MD 带灯自锁型 Maintained Illuminated LA115-B1-10MTD		两档自锁型 Maintained 2-Position LA115-B1-10X 两档自复型 Momentary 2-Position LA115-B1-10X/FU 带灯自锁型 Maintained Illuminated 2-Position LA115-B1-10XD 带灯自复型 Momentary Illuminated 2-Position LA115-B1-10XD/FU	
自复型 Momentary LA115-B1-10H 自锁型 Maintained LA115-B1-10HT 带灯自复型 Momentary Illuminated LA115-B1-10HD 带灯自锁型 Maintained Illuminated LA115-B1-10HTD		两档自锁型 Maintained 2-Position LA115-B1-10X 两档自复型 Momentary 2-Position LA115-B1-10X/FU 带灯自锁型 Maintained Illuminated 2-Position LA115-B1-10XD 带灯自复型 Momentary Illuminated 2-Position LA115-B1-10XD/FU	

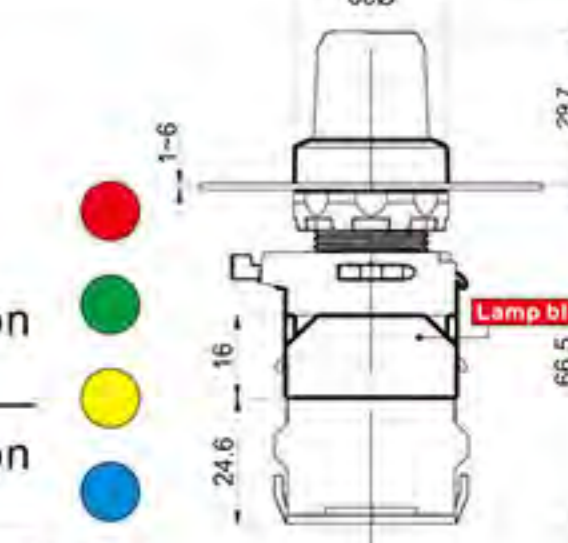
LA115-A/B按钮系列
LA115-A/B push button series

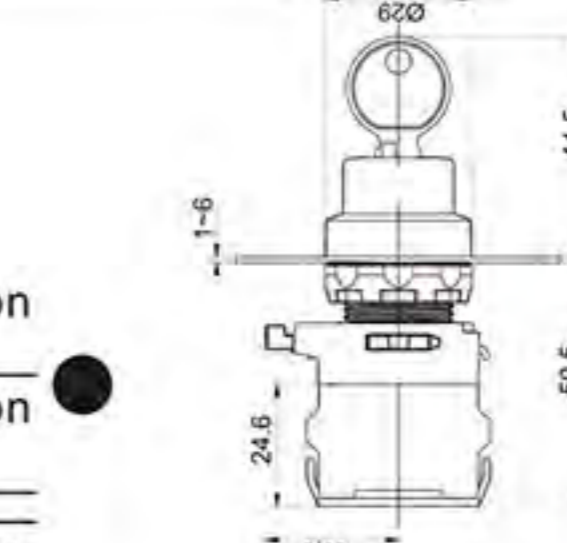
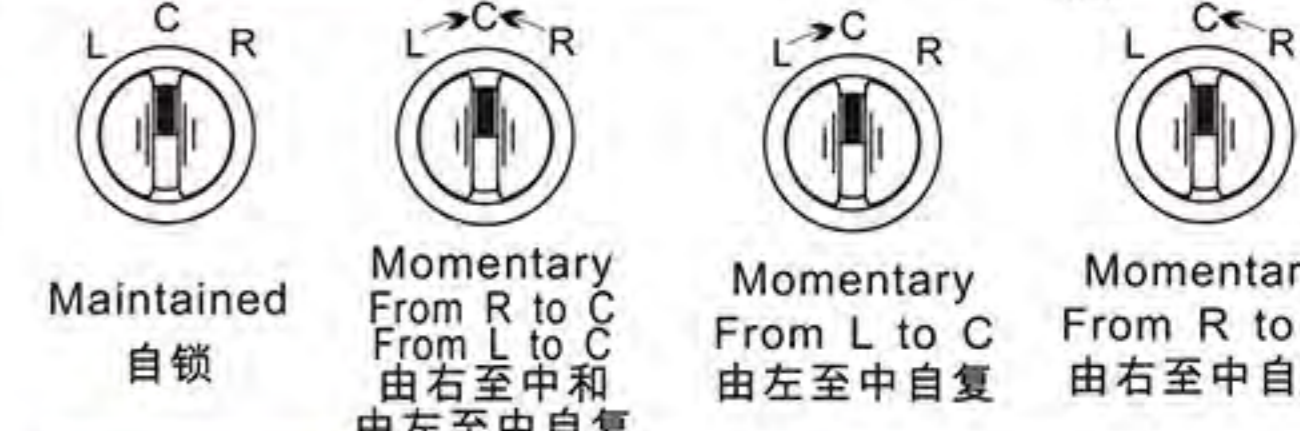
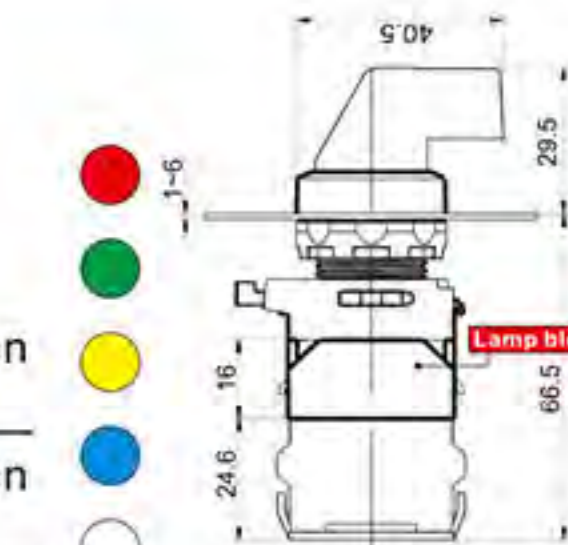
LA115-A/B按钮系列
LA115-A/B push button series

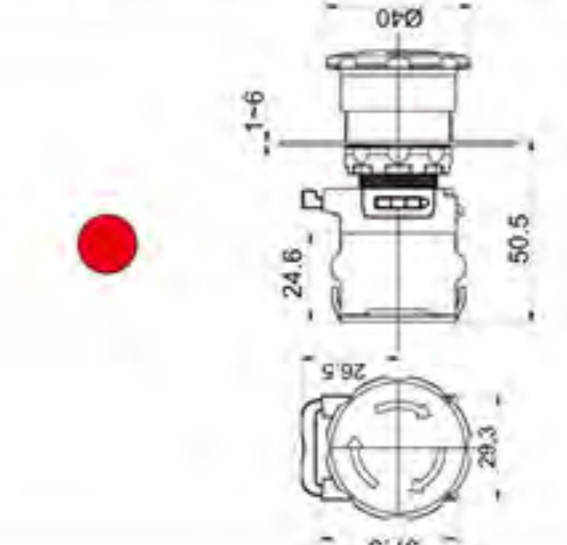
描述 Description	尺寸 Contour	描述 Description	尺寸 Contour
 <p>两档自锁型 Maintained 2-Position LA115-B1-10CX</p> <p>两档自复型 Momentary 2-Position LA115-B1-10CX/FU</p> <p>带灯自锁型 Maintained Illuminated 2-Position LA115-B1-10CXD</p> <p>带灯自复型 Momentary Illuminated 2-Position LA115-B1-10CXD/FU</p>	 <p>自锁 Maintained</p> <p>自复 Momentary</p>	 <p>两档自锁型 Maintained 2-Position LA115-B1-10Y</p> <p>两档自复型 Momentary 2-Position LA115-B1-10Y/FU</p> <p>三档自锁型 Maintained 3-Position LA115-B1-11YS</p> <p>三档自复型 Momentary 3-Position LA115-B1-11YS/FU</p>	
 <p>三档自锁型 Maintained 3-Position LA115-B1-11XS</p> <p>三档自复型 Momentary 3-Position LA115-B1-11XS/FU</p> <p>带灯自锁型 Maintained Illuminated LA115-B1-11XSD</p> <p>带灯自复型 Momentary Illuminated LA115-B1-11XSD/FU</p>		 <p>Maintained 自锁</p> <p>Momentary From R to C 由右至中和</p> <p>Momentary From L to C 由左至中自复</p> <p>Momentary From R to C 由右至中自复</p> <p>Momentary From L to C 由左至中自复</p>	
 <p>三档自锁型 Maintained 3-Position LA115-B1-11CXS</p> <p>三档自复型 Momentary 3-Position LA115-B1-11CXS/FU</p> <p>带灯自锁型 Maintained Illuminated LA115-B1-11CXSD</p> <p>带灯自复型 Momentary Illuminated LA115-B1-11CXSD/FU</p>		 <p>Maintained 自锁</p> <p>Momentary From R to C 由右至中和</p> <p>Momentary From L to C 由左至中自复</p> <p>Momentary From R to C 由右至中自复</p> <p>Momentary From L to C 由左至中自复</p>	
 <p>旋转释放 Twist Release 不带灯型 Non-illuminated LA115-B1-01ZS</p>		 <p>自复型 Momentary LA115-B2-10</p> <p>自锁型 Maintained LA115-B2-10T</p> <p>带灯自复型 Momentary Illuminated LA115-B2-10D</p> <p>带灯自锁型 Maintained Illuminated LA115-B2-10TD</p>	

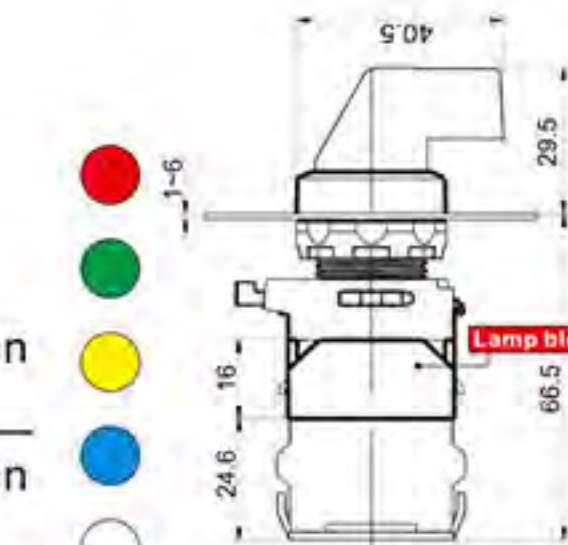
描述 Description	尺寸 Contour	描述 Description	尺寸 Contour
 <p>自复型 Momentary LA115-B2-10M</p> <p>自锁型 Maintained LA115-B2-10MT</p> <p>带灯自复型 Momentary Illuminated LA115-B2-10MD</p> <p>带灯自锁型 Maintained Illuminated LA115-B2-10MTD</p>	 <p>Maintained</p> <p>自锁 Maintained</p> <p>自复 Momentary</p>	 <p>两档自锁型 Maintained 2-Position LA115-B2-10CX</p> <p>两档自复型 Momentary 2-Position LA115-B2-10CX/FU</p> <p>带灯自锁型 Maintained Illuminated 2-Position LA115-B2-10CXD</p> <p>带灯自复型 Momentary Illuminated 2-Position LA115-B2-10CXD/FU</p>	 <p>自锁 Maintained</p> <p>自复 Momentary</p>
 <p>两档自锁型 Maintained 2-Position LA115-B2-10X</p> <p>两档自复型 Momentary 2-Position LA115-B2-10X/FU</p> <p>带灯自锁型 Maintained Illuminated 2-Position LA115-B2-10XD</p> <p>带灯自复型 Momentary Illuminated 2-Position LA115-B2-10XD/FU</p>	 <p>自锁 Maintained</p> <p>自复 Momentary</p>	 <p>三档自锁型 Maintained 3-Position LA115-B2-11XS</p> <p>三档自复型 Momentary 3-Position LA115-B2-11XS/FU</p> <p>带灯自锁型 Maintained Illuminated LA115-B2-11XSD</p> <p>带灯自复型 Momentary Illuminated LA115-B2-11XSD/FU</p>	
 <p>两档自锁型 Maintained 2-Position LA115-B2-10Y</p> <p>两档自复型 Momentary 2-Position LA115-B2-10Y/FU</p> <p>三档自锁型 Maintained 3-Position LA115-B2-11YS</p> <p>三档自复型 Momentary 3-Position LA115-B2-11YS/FU</p>		 <p>Maintained 自锁</p> <p>Momentary From R to C 由右至中和</p> <p>Momentary From L to C 由左至中自复</p> <p>Momentary From R to C 由右至中自复</p> <p>Momentary From L to C 由左至中自复</p>	
 <p>旋转释放 Twist Release 不带灯型 Non-illuminated LA115-B2-01ZS</p>		 <p>三档自锁型 Maintained 3-Position LA115-B2-11CXSD</p> <p>三档自复型 Momentary 3-Position LA115-B2-11CXSD/FU</p> <p>带灯自锁型 Maintained Illuminated LA115-B2-11CXSD</p> <p>带灯自复型 Momentary Illuminated LA115-B2-11CXSD/FU</p>	

LA115-A/B按钮系列
LA115-A/B push button series

LA115-A/B按钮系列
LA115-A/B push button series

描述 Description & 颜色 Color

 LA115-1-BN
Momentary
平钮头部
(自复)

 LA115-1-T
Maintained
平钮头部
(自锁)

Flush Button

 LA115-1-D
Momentary
平钮头部
(带灯自复)

 LA115-1-TD
Maintained
平钮头部
(带灯自锁)

Flush Button Illuminated

 LA115-1-H
Momentary
凸钮头部
(自复)

 LA115-1-HT
Maintained
凸钮头部
(自锁)

Extended Button

 LA115-1-HD
Momentary
凸钮头部
(带灯自复)

 LA115-1-HTD
Maintained
凸钮头部
(带灯自锁)

Extended Button Illuminated

 LA115-1-M
Momentary
蘑菇钮头部
(自复)

 LA115-1-MT
Maintained
蘑菇钮头部
(自锁)

Mushroom Button

 LA115-1-MD
Momentary
蘑菇钮头部
(带灯自复)

 LA115-1-MTD
Maintained
蘑菇钮头部
(带灯自锁)

Mushroom Button Illuminated

 LA115-1-ZS
Twist Release
Non-illuminated
急停头部
旋转释放
(不带灯型)

Emergency Stop Pushbutton

 LA115-2-BN
Momentary
平钮头部
(自复)

 LA115-2-T
Maintained
平钮头部
(自锁)

Flush Button

 LA115-2-D
Momentary
平钮头部
(带灯自复)

 LA115-2-TD
Maintained
平钮头部
(带灯自锁)

Flush Button Illuminated

描述 Description & 颜色 Color

 LA115-1-XS
Momentary
2&3-Positon
两/三档自复旋钮

 LA115-1-X
Maintained
2&3-Positon
两/三档自锁旋钮

Short Handle Selector

 LA115-1-XS
Momentary
2&3-Positon
两/三档自复旋钮
(带灯型)

 LA115-1-X
Maintained
2&3-Positon
两/三档自锁旋钮
(带灯型)

Short Handle Selector Illuminated

 LA115-1-CX
Maintained
2&3-Positon
两/三档长柄旋钮
(自锁型)

 LA115-1-CX/FU
Momentary
2&3-Positon
两/三档长柄旋钮
(自复型)

Selector Long Handle

 LA115-1-CXD
Maintained
2&3-Positon
两/三档长柄旋钮
(带灯自锁型)

 LA115-1-CXD/FU
Momentary
2&3-Positon
两/三档长柄旋钮
(带灯自复型)

Selector Long Handle Illuminated

 LA115-1-R

双键平钮
Double (Flush Botton)

ON	OFF
START	STOP

 LA115-1-RD

双键带灯平钮
Double (Flush Botton) Illuminated

ON	OFF
START	STOP

 LA115-1-Y/FU
Momentary
2/3-Positon
两/三档自复型

 LA115-1-YS
Maintained
2/3-Positon
两/三档自锁型

Key-operated Selector

 LA115-2-XS/FU
Momentary
2&3-Positon
两/三档自复旋钮

 LA115-2-X
Maintained
2&3-Positon
两/三档自锁旋钮

Short Handle Selector

 LA115-2-XSD/FU
Momentary
2&3-Positon
两/三档自复旋钮
(带灯型)

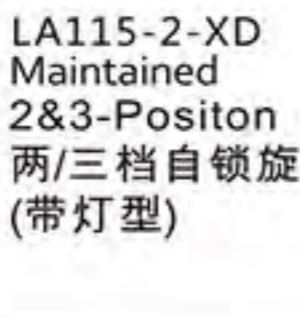
 LA115-2-XD
Maintained
2&3-Positon
两/三档自锁旋钮
(带灯型)

Short Handle Selector Illuminated

描述 Description & 颜色 Color

 LA115-2-H
Momentary
凸钮头部
(自复)

 LA115-2-HT
Maintained
凸钮头部
(自锁)

Extended Button

 LA115-2-HD
Momentary
凸钮头部
(带灯自复)

 LA115-2-HTD
Maintained
凸钮头部
(带灯自锁)

Extended Button Illuminated

 LA115-2-M
Momentary
蘑菇钮头部
(自复)

 LA115-2-MT
Maintained
蘑菇钮头部
(自锁)

Mushroom Button

 LA115-2-MD
Momentary
蘑菇钮头部
(带灯自复)

 LA115-2-MTD
Maintained
蘑菇钮头部
(带灯自锁)

Mushroom Button Illuminated

 LA115-2-ZS
Twist Release
Non-illuminated
急停头部
旋转释放
(不带灯型)

Emergency Stop Pushbutton

描述 Description & 颜色 Color

 LA115-2-CX
Maintained
2&3-Positon
两/三档长柄旋钮
(自锁型)

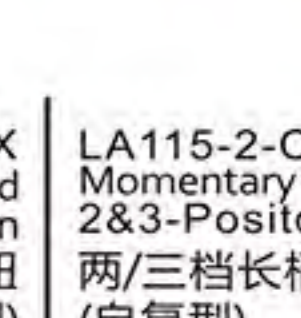
 LA115-2-CX/FU
Momentary
2&3-Positon
两/三档长柄旋钮
(自复型)

Selector Long Handle

 LA115-2-CXD
Maintained
2&3-Positon
两/三档长柄旋钮
(带灯自锁型)

 LA115-2-CXD/FU
Momentary
2&3-Positon
两/三档长柄旋钮
(带灯自复型)

Selector Long Handle Illuminated

 LA115-2-R

双键平钮
Double (Flush Botton)

ON	OFF
START	STOP

 LA115-2-RD

双键带灯平钮
Double (Flush Botton) Illuminated

ON	OFF
START	STOP

 LA115-2-Y/FU
Momentary
2/3-Positon
两/三档自复型

 LA115-1-YS
Maintained
2/3-Positon
两/三档自锁型

Key-operated Selector

样式 Photo | 描述 Description | 样式 Photo | 描述 Description | 样式 Photo | 描述 Description

 NO -3 -4
LA115-A-10
常开触点模块
Contact block

 NO -3 -4
NC -1 -2
LA115-B-11
Contact block 1常开1常闭触点模块(B型)

 1NC LA115-A-Z01

 1NO LA115-A-Z10

 1NO 1NC LA115-A-Z11

 NC -1 -2
LA115-A-01
常闭触点模块
Contact block

 R--红色 B--蓝色
G--绿色 W--白色
Y--黄色
一体式LED灯座(B型)
Lamp block with LED

 1NC LA115-A-Z01

 1NO LA115-A-Z10

 1NO 1NC LA115-A-Z11

 X1 X2
LA115-A-Z
A型中座
(可接三副模块)
For three blocks

 R--红色 (red)
G--绿色 (green)
Y--黄色 (yellow)
B--蓝色 (blue)
W--白色 (white)

 X1 X2
LA115-A-D2
一体式LED灯座
Integrated lamp block

 LA115-B-Z
B型中座
(可接一副模块)
For one block

 LA115-22FF
紧固圈(防松)
Fastening ring (anti loosening)

LA115-A/B按钮系列
LA115-A/B push button series

LA115-A/B按钮系列
LA115-A/B push button series

描述 Description | 尺寸 Contour



自复型 Momentary
LA115-B8-10



自锁型 Maintained
LA115-B8-10T

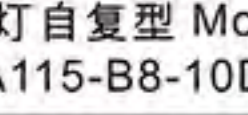

带灯自复型 Momentary Illuminated
LA115-B8-10D

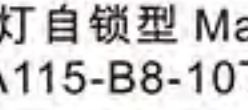

带灯自锁型 Maintained Illuminated
LA115-B8-10TD

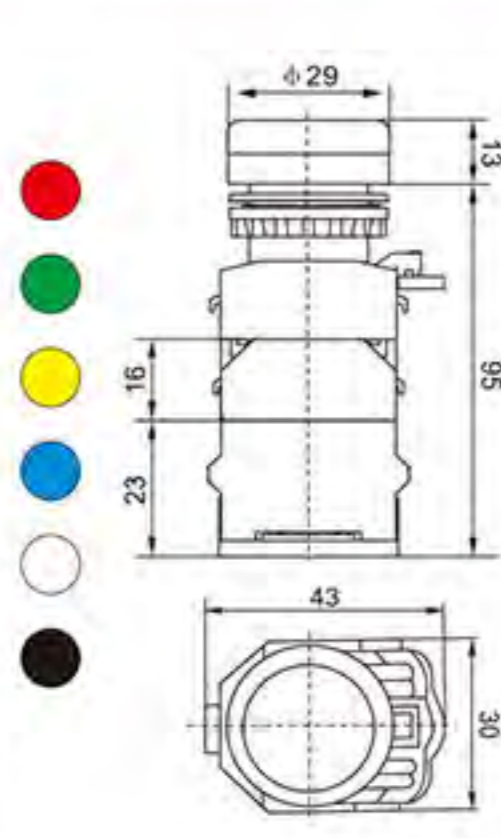

描述 Description | 尺寸 Contour



两档自锁型 Maintained 2-Position
LA115-B8-10X

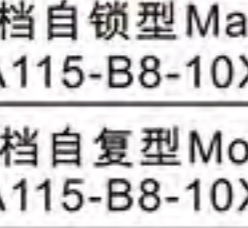



两档自复型 Momentary 2-Position
LA115-B8-10X/FU

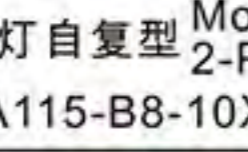

带灯自锁型 Maintained Illuminated
2-Position
LA115-B8-10XD

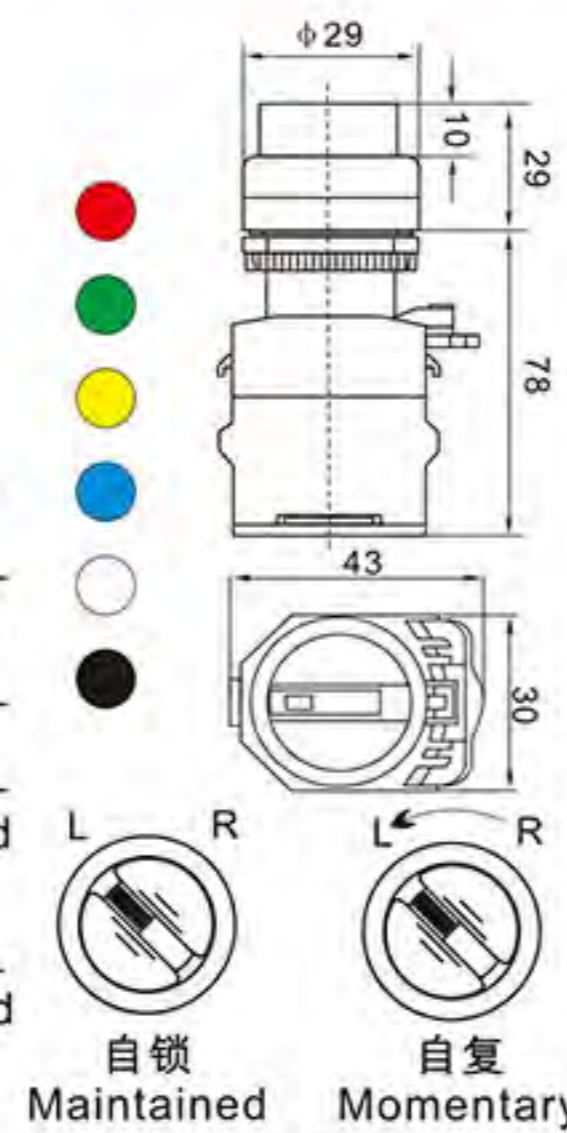

带灯自复型 Momentary Illuminated
2-Position
LA115-B8-10XD/FU

自复型 Momentary
LA115-B8-10H



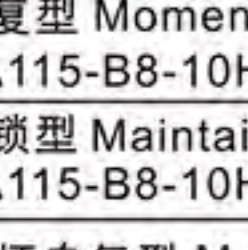

自锁型 Maintained
LA115-B8-10HT

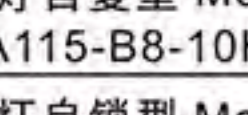

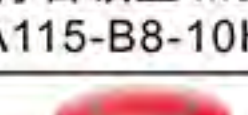
带灯自复型 Momentary Illuminated
LA115-B8-10HD

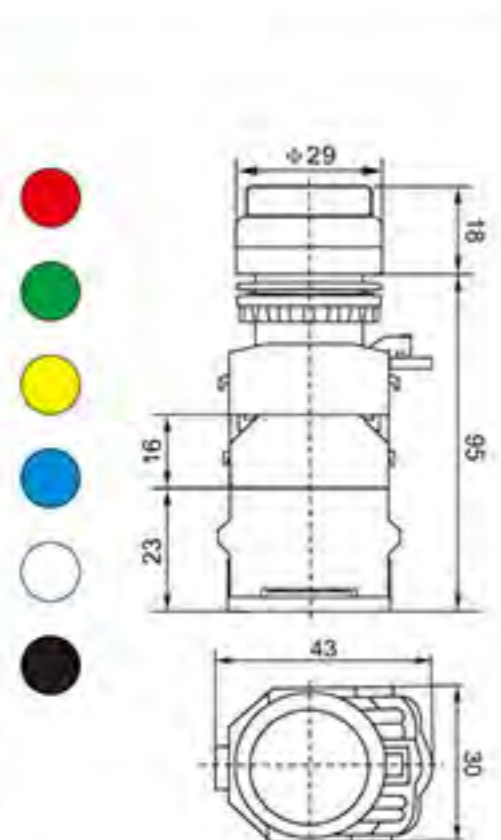

带灯自锁型 Maintained Illuminated
LA115-B8-10HTD

三档自锁型 Maintained 3-Position
LA115-B8-11XS



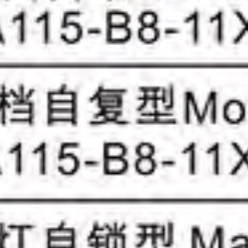

三档自复型 Momentary 3-Position
LA115-B8-11XS/FU

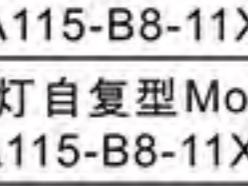

带灯自锁型 Maintained Illuminated
LA115-B8-11XSD

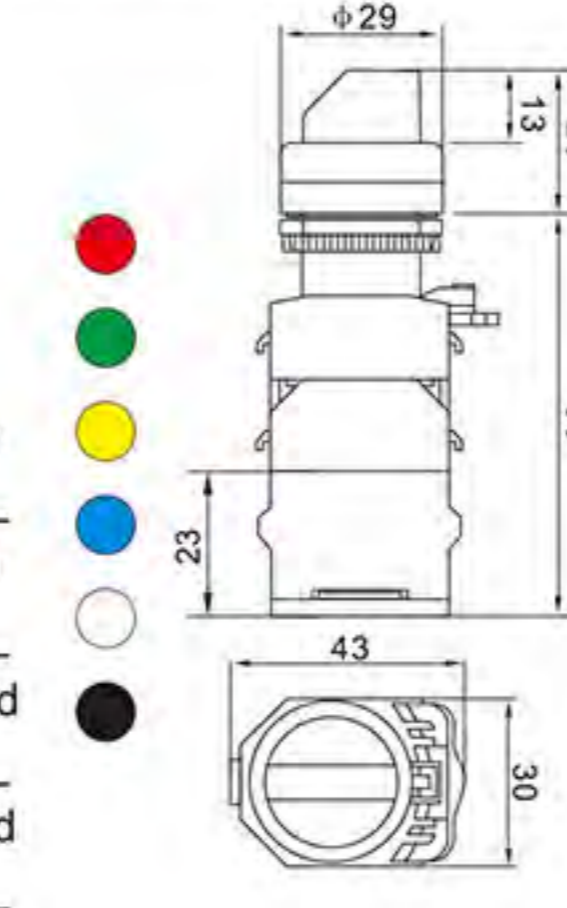

带灯自复型 Momentary Illuminated
LA115-B8-11XSD/FU

自复型 Momentary
LA115-B8-10M





自锁型 Maintained
LA115-B8-10MT

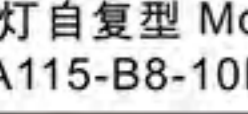

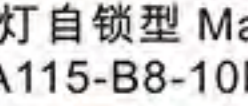
带灯自复型 Momentary Illuminated
LA115-B8-10MD



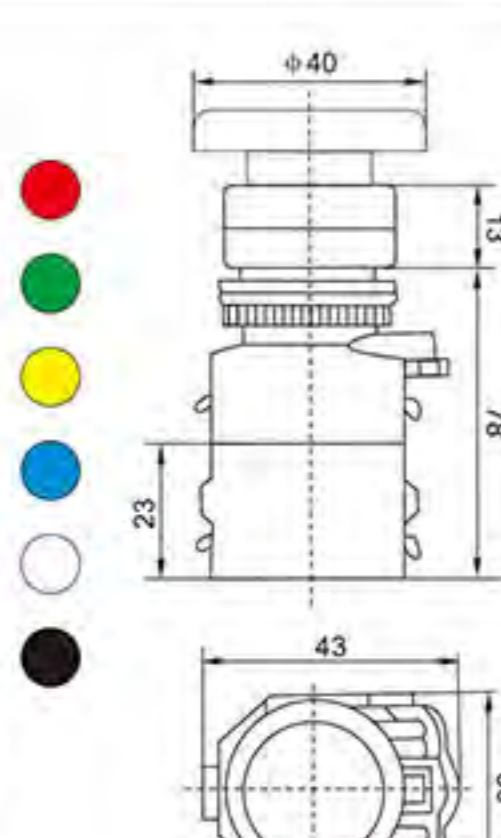

带灯自锁型 Maintained Illuminated
LA115-B8-10MTD

两档自锁型 Maintained 2-Position
LA115-B8-10CX



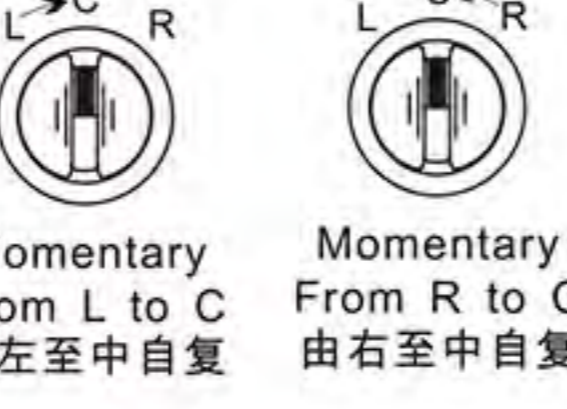

两档自复型 Momentary 2-Position
LA115-B8-10CX/FU

不带灯自复型 Non-illuminated
Momentary
LA115-B8-11R

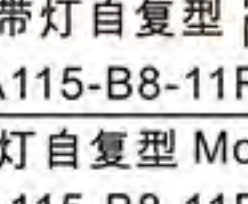

带灯自复型 Momentary Illuminated
LA115-B8-11RD

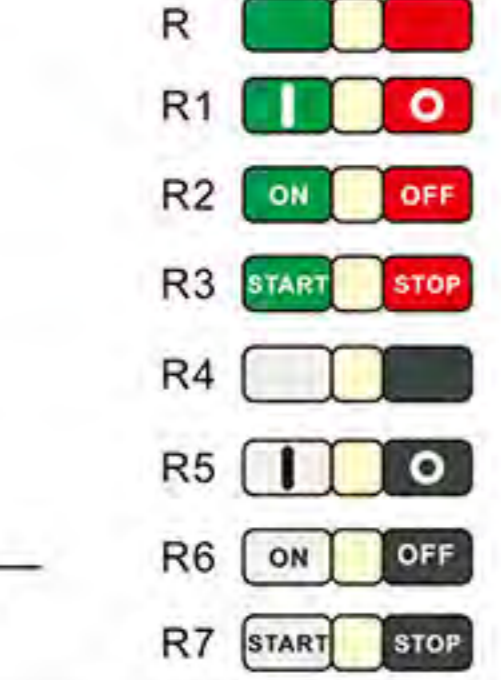
两档自锁型 Maintained 2-Position
LA115-B8-10CX

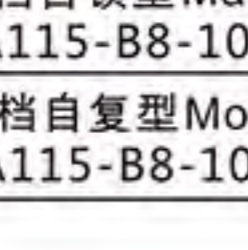

两档自复型 Momentary 2-Position
LA115-B8-10CX/FU

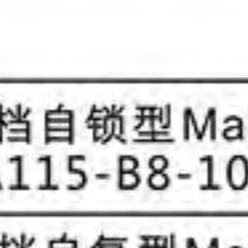

三档自锁型 Maintained 3-Position
LA115-B8-10CX

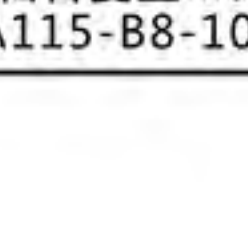

三档自复型 Momentary 3-Position
LA115-B8-10CX/FU

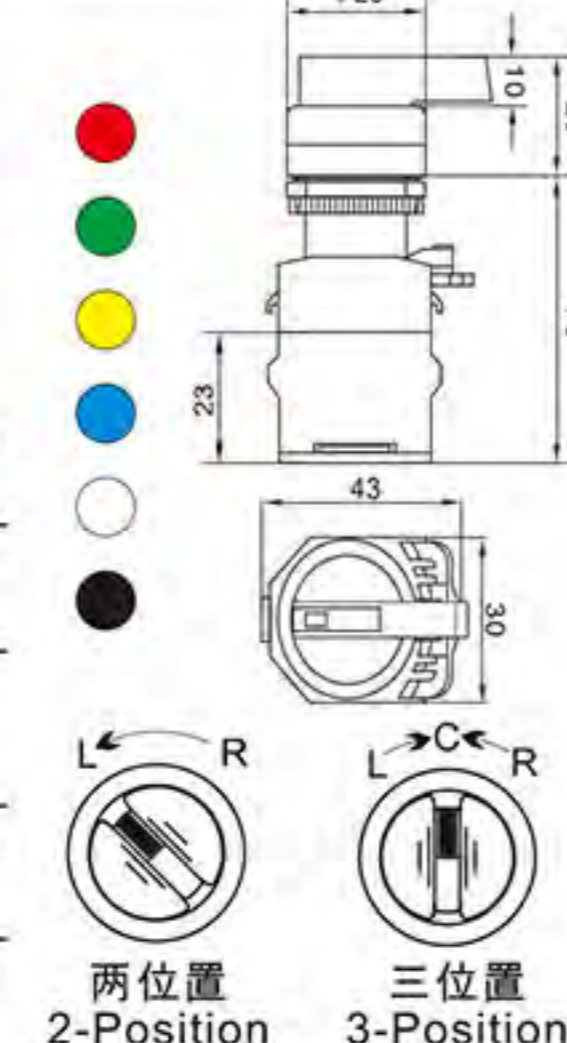

描述 Description | 尺寸 Contour



两档自锁型 Maintained 2-Position
LA115-B8-01Y

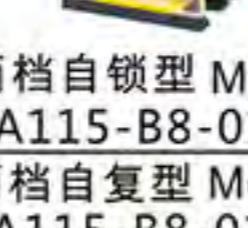

两档自复型 Momentary 2-Position
LA115-B8-01Y/FU

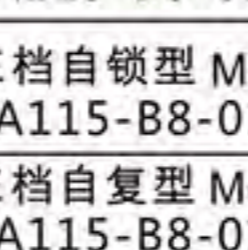

三档自锁型 Maintained 3-Position
LA115-B8-01YS



三档自复型 Momentary 3-Position
LA115-B8-01YS/FU

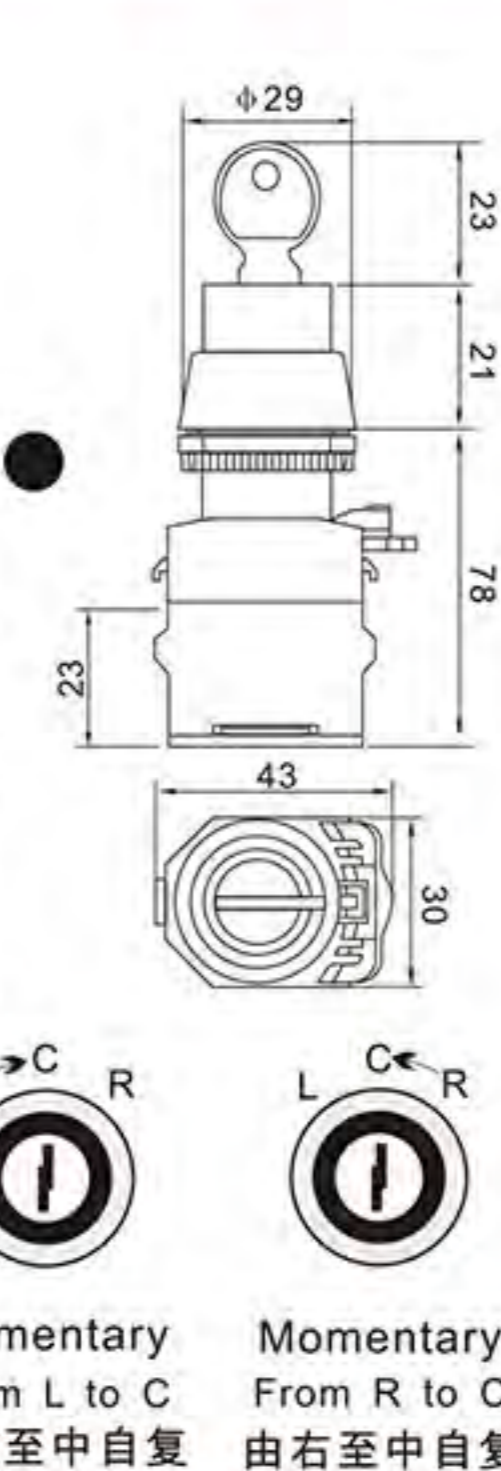

描述 Description | 尺寸 Contour



钥匙旋转释放 Key Release
不带灯型 Non-illuminated
LA115-B8-11ZY



旋转释放 Twist Release
不带灯型 Non-illuminated
LA115-B8-11ZS

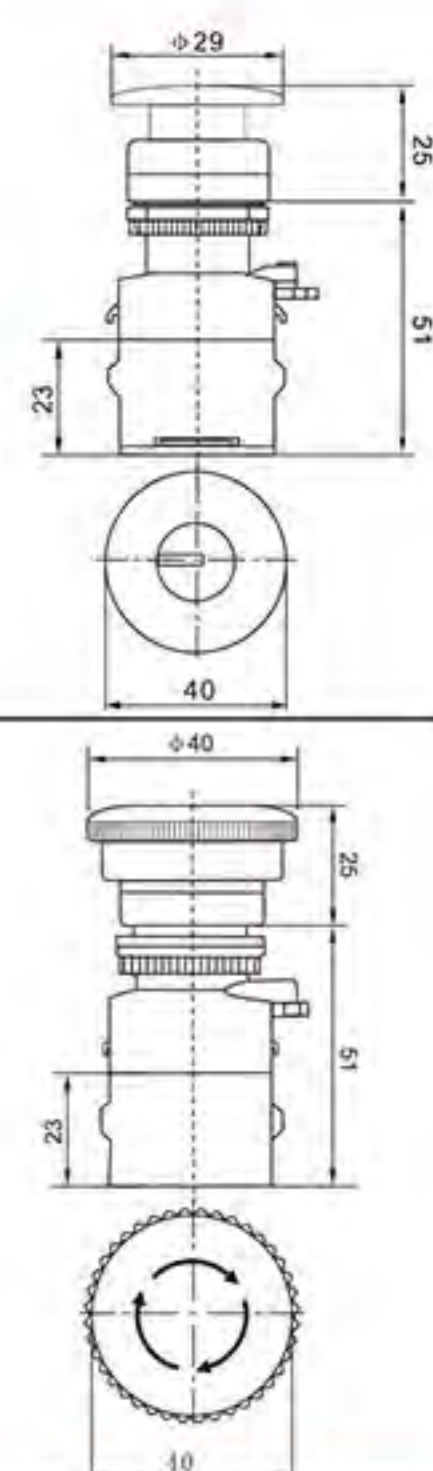

描述 Description | 尺寸 Contour



自复型 Momentary
LA115-B9-10

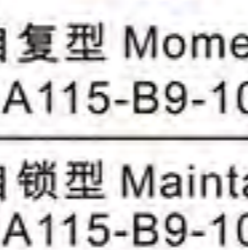

自锁型 Maintained
LA115-B9-10T

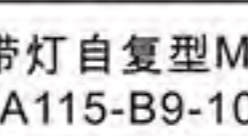

带灯自复型 Momentary Illuminated
LA115-B9-10D

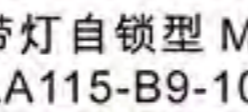

带灯自锁型 Maintained Illuminated
LA115-B9-10TD

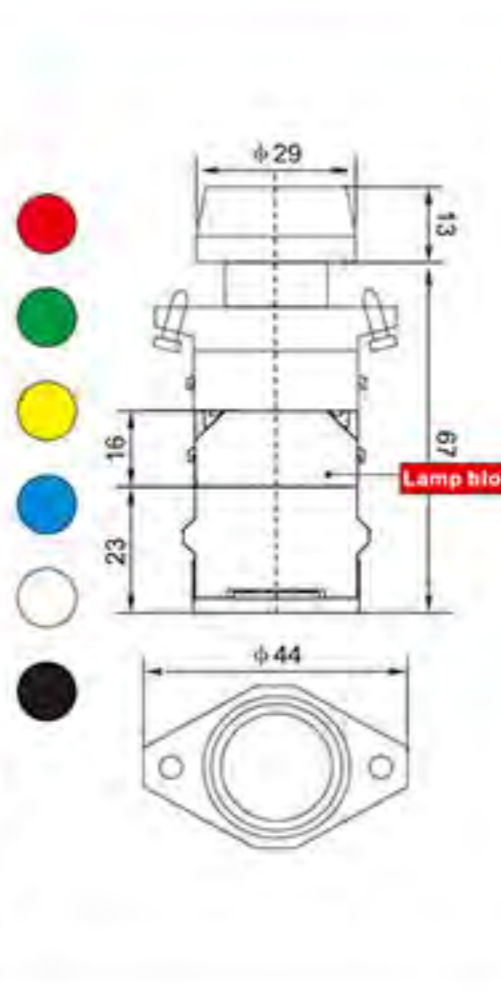

描述 Description | 尺寸 Contour



自复型 Momentary
LA115-B9-10M



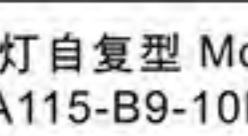

自锁型 Maintained
LA115-B9-10MT

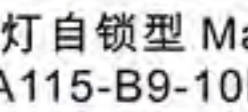

带灯自复型 Momentary Illuminated
LA115-B9-10MD

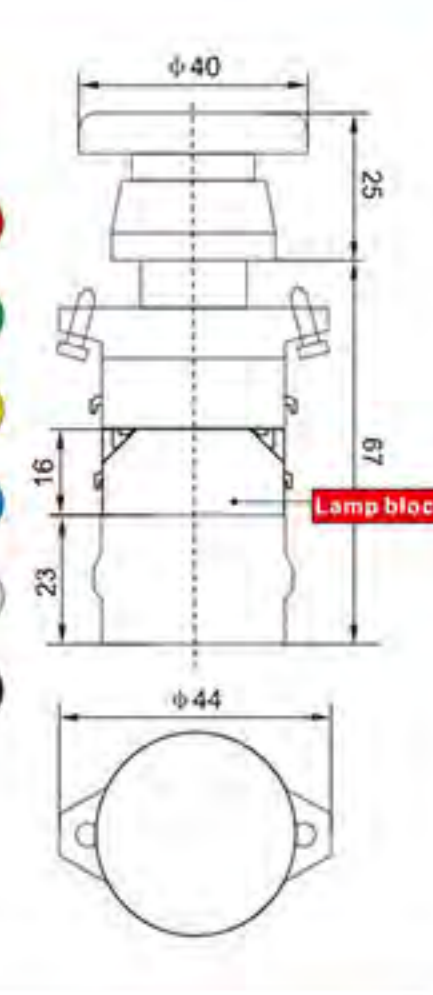

带灯自锁型 Maintained Illuminated
LA115-B9-10MTD

自复型 Momentary
LA115-B9-10H





自锁型 Maintained
LA115-B9-10HT

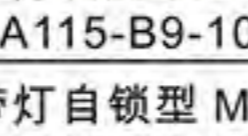

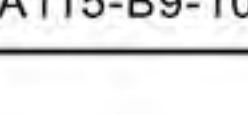
带灯自复型 Momentary Illuminated
LA115-B9-10HD

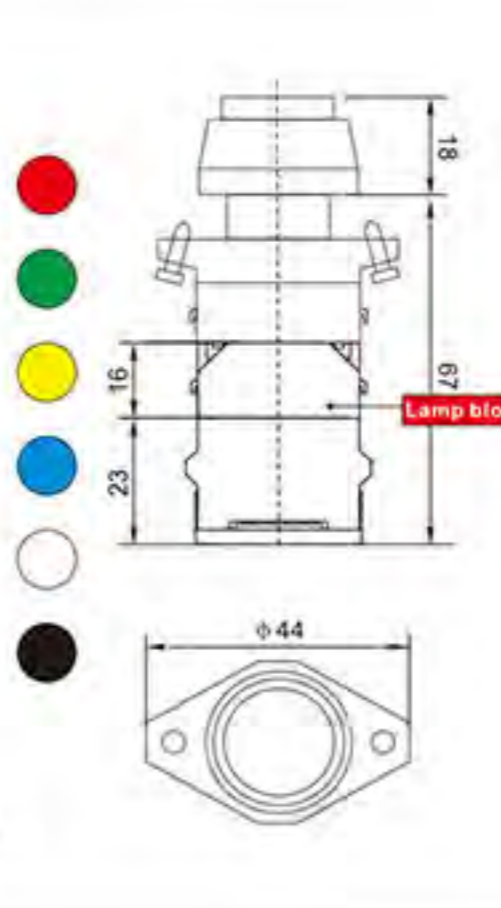

带灯自锁型 Maintained Illuminated
LA115-B9-10HTD

不带灯自复型 Non-illuminated
Momentary
LA115-B9-11R

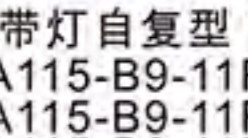

带灯自复型 Momentary Illuminated
LA115-B9-11R1

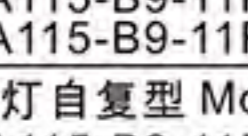

带灯自复型 Momentary Illuminated
LA115-B9-11R2

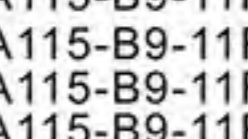



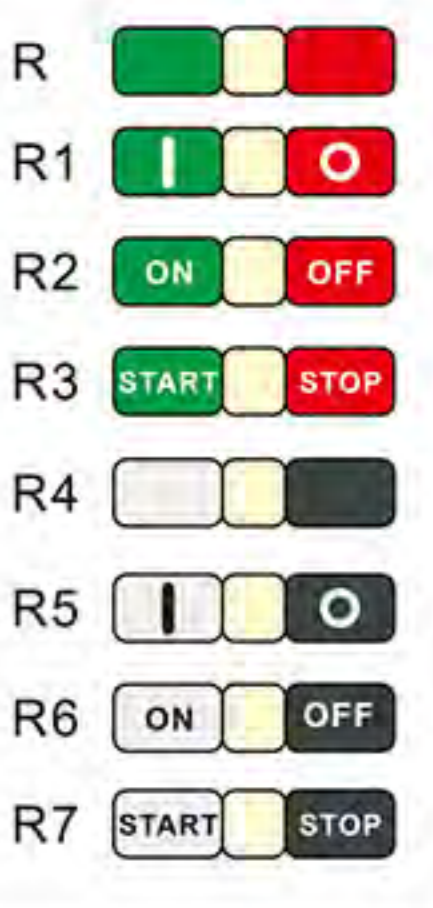





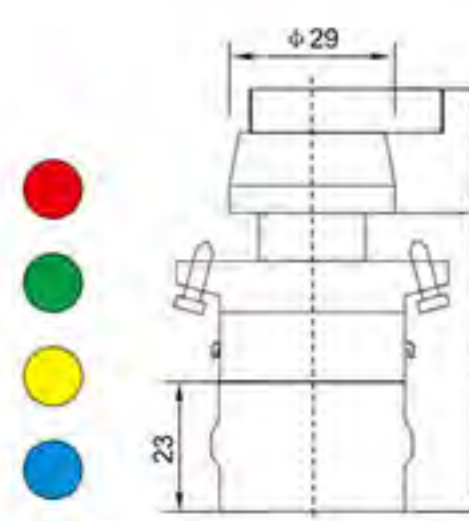
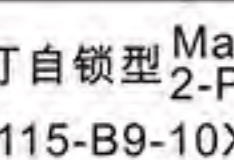
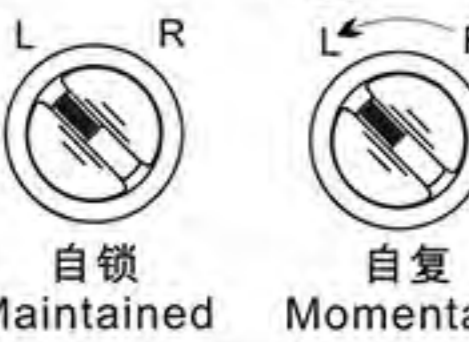

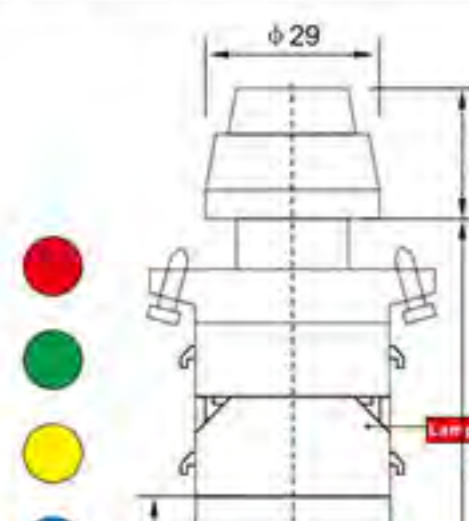
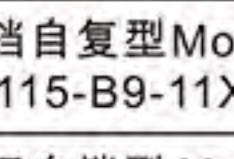
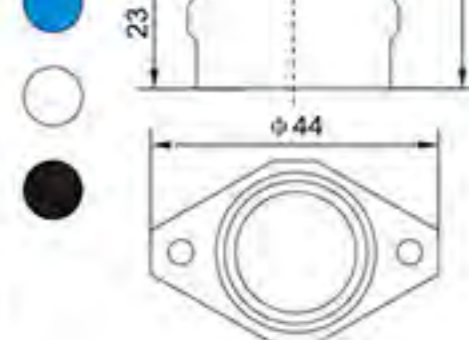

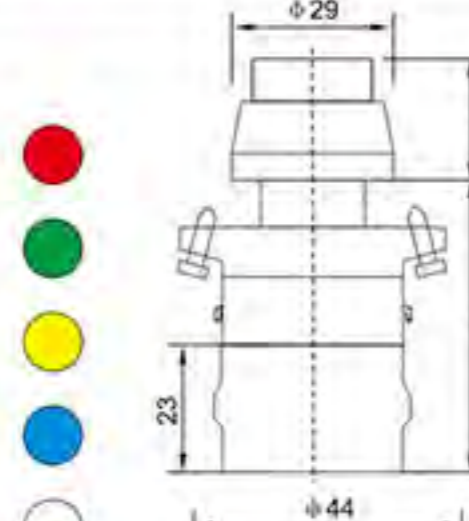
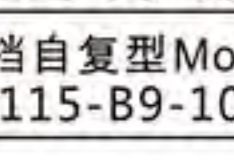
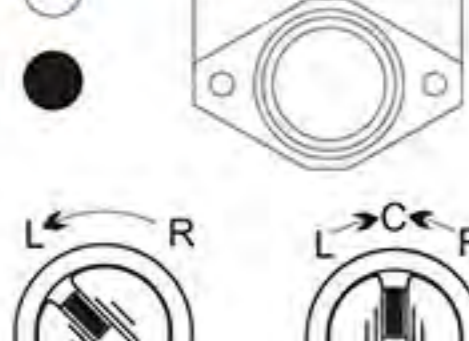
带灯自复型 Momentary Illuminated
LA115-B9-11R3

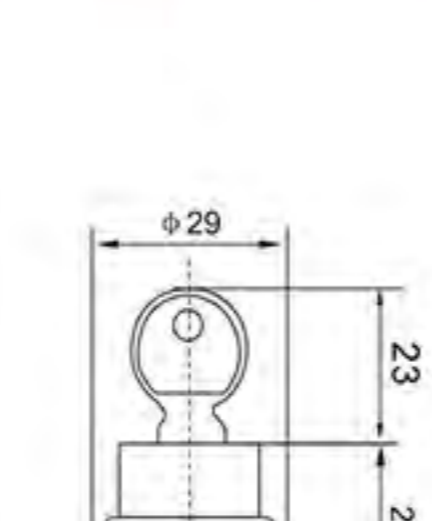

LA115-A/B按钮系列
LA115-A/B push button series

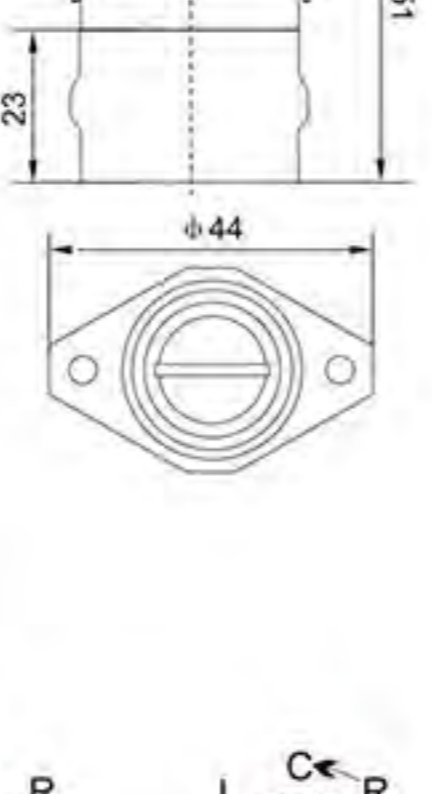
LA115-A/B按钮系列
LA115-A/B push button series

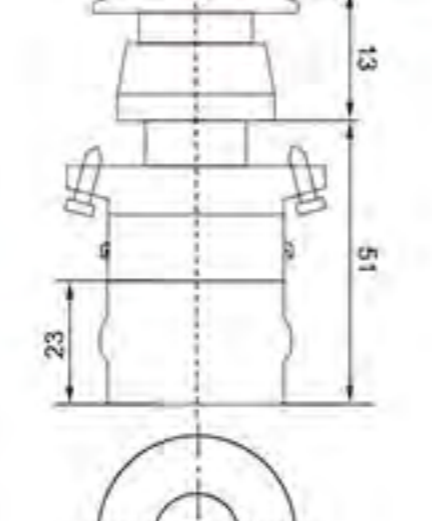
描述 Description	尺寸 Contour
 <p>两档自锁型 Maintained 2-Position LA115-B9-10X</p> <p>两档自复型 Momentary 2-Position LA115-B9-10X/FU</p>	
 <p>带灯自锁型 Maintained Illuminated 2-Position LA115-B9-10XD</p> <p>带灯自复型 Momentary Illuminated 2-Position LA115-B9-10XD/FU</p>	
 <p>三档自锁型 Maintained 3-Position LA115-B9-11XS</p> <p>三档自复型 Momentary 3-Position LA115-B9-11XS/FU</p>	
 <p>带灯自锁型 Maintained Illuminated LA115-B9-11XSD</p> <p>带灯自复型 Momentary Illuminated LA115-B9-11XSD/FU</p>	
 <p>两档自锁型 Maintained 2-Position LA115-B9-10CX</p> <p>两档自复型 Momentary 2-Position LA115-B9-10CX/FU</p>	
 <p>三档自锁型 Maintained 3-Position LA115-B9-10CXS</p> <p>三档自复型 Momentary 3-Position LA115-B9-10CXS/FU</p>	

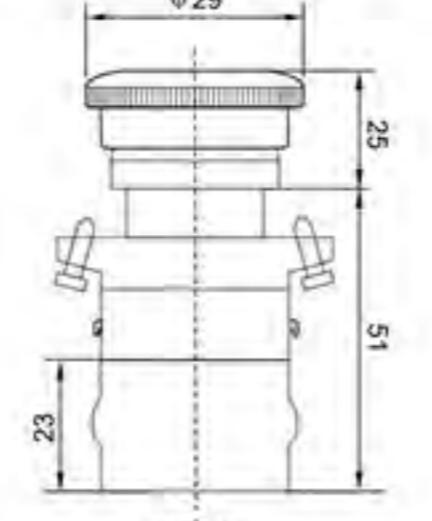
描述 Description	尺寸 Contour
 <p>两档自锁型 Maintained 2-Position LA115-B9-10Y</p> <p>两档自复型 Momentary 2-Position LA115-B9-10Y/FU</p>	
 <p>三档自锁型 Maintained 3-Position LA115-B9-11YS</p> <p>三档自复型 Momentary 3-Position LA115-B9-11YS/FU</p>	
 <p>钥匙旋转释放 Key Release 不带灯型 Non-illuminated LA115-B9-01ZY</p>	
 <p>旋转释放 Twist Release 不带灯型 Non-illuminated LA115-B9-10ZS</p>	

型号及其含义 Mode and Meaning

GXB2-□□□□□
GXB4-□□□□□

派生产品 Derivative product BA 3:带符号 (仅限于BA,BL) With Mark (BA,BL Only)

颜色 Colour 选择开关 Selector Switch BD BJ BG
 1:白 White 2:二位置自锁 2-position (Maintained)
 3:绿 Green 3:三位置自锁 3-position (Maintained)
 4:红 Red 4:二位置由右至左自复 2-position (Momentary,R to L)
 5:黄 Yellow 5:三位置由右至中和由左至中自复 3-position (Momentary,R to C&L to C)
 6:蓝 Blue 6:三位置由右至中自复 3-position (Momentary,R to C)
 7:三位置由左至中自复 3-position (Momentary,L to C)

触点模块 Contact Block
 1:1常开 1NO
 2:1常闭 1NC
 3:2常开 2NO
 4:2常闭 2NC
 5:1常开+1常闭 1NO+1NC

A:平头按钮 Flush Pushbutton
 L:凸头按钮 Extended Pushbutton
 P:带罩按钮 Pushbutton (Cover)
 W:带灯按钮 Pushbutton (Illuminated)
 D:选择开关(短柄) Selector Switch (Short-handle)
 J:选择开关(长柄) Selector Switch (long-handle)
 G:钥匙开关 Key-operated
 E:触点模块 Contact Block
 Z:触点模块加中座 Contact Block+Holder

B:金属系列 Metal Series
 E:塑料系列 Plastic Series

B:蘑菇头按钮 Φ30 / Pushbutton,Mushroom(Φ30)
 C:蘑菇头按钮 Φ40 / Pushbutton,Mushroom(Φ40)
 R:蘑菇头按钮 Φ60 / Pushbutton,Mushroom(Φ60)
 S4:急停按钮(旋转释放,Φ30) Emergency Stop Pushbutton(Twist Release,Φ30)
 S5:急停按钮(旋转释放,Φ40) Emergency Stop Pushbutton(Twist Release,Φ40)
 S6:急停按钮(旋转释放,Φ60) Emergency Stop Pushbutton(Twist Release,Φ60)
 T:急停按钮(拉拔释放) Emergency Stop Pushbutton(Pull Release)
 V:指示灯 Pilot Light

使用环境条件 Working Environment

- 工作温度: -25~+70°C Working environment temperature
- 储存温度: -40~+70°C Storage temperature
- 污染等级: 3级 Class of pollution
- 防护等级: IP40/IP65/IP66 Protection grade: IP40/IP65/IP66
- 海拔极限高度: ≤2000米 Limit height: ≤2000米
- 符合标准 Standard EN 60947-1,GB14048.5

主要技术参数 Main Technical Data

- 额定绝缘电压: 600V Rated insulation voltage
- 约定发热电流: 10A Rated thermal current
- 开关额定值: AC-15 Ue:380V/250V,Ie=4.5A Switch rating DC-13 Ue:220V/110V,Ie=0.6A
- 接触电阻: ≤50mΩ Contact resistance
- 推荐扭力: 0.9Nm Recommended torque
- 接线面积: 最小(min)1×0.5mm²,最大(Max)2×1.5mm²或(or)1×2.5mm² Connectable area
- 机械寿命: 按钮(Pushbutton)≥300×10⁴次(times);旋钮(Selector Switch)≥1004次(times); Mechanical life
- 急停按钮(Emergency Stop Pushbutton)≥30×10⁴次(times)
- 电气寿命: ≥30×10⁴次 Electrical life
- 灯电压极限: 0.8Ue≤U≤1.15Ue Limit voltage(lamp)

描述 Description	尺寸 Contour	描述 Description	尺寸 Contour
Flush Button Momentary 平钮 弹簧返回 自复型 GXB2-EA42		Extended button Momentary 凸钮 弹簧返回 自复型 GXB2-EL31	
Flush Button Momentary (with waterproof cover) 平钮(防水罩) 弹簧返回 自复型 GXB2-EP33		Extended button Momentary Marked 凸钮(带符号) 弹簧返回 自复型 GXB2-EL3361	
Flush Button Momentary Marked 平钮(带符号) 弹簧返回 自复型 GXB2-EA3341		Mushroom button Momentary 蘑菇头按钮 弹簧返回 自复型 Φ40 GXB2-EC42 Φ40	
Mushroom button Momentary 蘑菇头按钮 弹簧返回 自复型 Φ60 GXB2-ER42 Φ60		Selector Switch Short-handle 短柄旋钮 GXB2-ED41 GXB2-ED21	
Selector Switch long-handle 长柄旋钮 GXB2-EJ41 GXB2-EJ53		Key-operated 钥匙钮 GXB2-EG45 GXB2-EG53	

Explanation of Type Designation(型号命名方式解释)

Example(示例):
GXB2 - EA 3 1

1 = 1NO 2 = 1NC 3 = 2NO 4 = 2NC 5 = 1NO+1NC	331 334 432 336 335 533 434
1 = White(白) 2 = Black(黑) 3 = Green(绿) 4 = Red(红) 5 = Yellow(黄) 6 = Blue(蓝)	
EA Flush Pushbutton(Momentary) 平钮(自复型)	EC Pushbutton, Mushroom(Momentary, Φ40) 蘑菇头按钮(自复型, Φ40)
EL Extended Pushbutton(Momentary) 凸钮(自复型)	ER Pushbutton, Mushroom(Momentary, Φ60) 蘑菇头按钮(自复型, Φ60)
EP Flush Pushbutton(Cover)(Momentary) 平钮(自复型, 带防水罩)	

Example(示例):
GXB2 - ED 3 1

1 = 1NO 2 = 1NC 3 = 2NO 4 = 2NC 5 = 1NO+1NC	2: 二位置自锁 2-position (Maintained)	4: 二位置由右至左自复 2-position (Momentary, R to L)
	3: 三位置自锁 3-position (Maintained)	5: 三位置由右至中和由左至中自复 3-position (Momentary, R to C & L to C)
	6: 三位置由右至中自复 3-position (Momentary, R to C)	7: 三位置由左至中自复 3-position (Momentary, L to C)
	D: 选择开关(短柄) Selector Switch(Short-handle)	J: 选择开关(长柄) Selector Switch(long-handle)
	G: 钥匙开关 Key-operated	

描述 Description	尺寸 Contour	描述 Description	尺寸 Contour
Twist Release 旋转释放 急停钮 GXB2-ES442 Φ30		Double Flush Button Direct Supply 双键平钮 直接插入方式 12~240V Ba9s Bulb (LED/Neon) 提供12~240V灯泡 GXB2-EW81364	
Twist Release 旋转释放 急停钮 GXB2-ES542 Φ40		Extended/Flush Button Direct Supply 双键凸平钮 直接插入方式 12~240V Ba9s Bulb (LED/Neon) 提供12~240V灯泡 GXB2-EW84364	
Pull Release 拉拔释放 急停钮 GXB2-ET42 Φ40		Double Flush button with waterproof cover Unmarked IP65 双键平钮 带防水罩 GXB2-EL9134	
Key Release 钥匙旋转释放 急停钮 GXB2-ES142		Double Extended/flush button with waterproof cover Unmarked IP65 双键凸平钮 带防水罩 GXB2-EL9334	
Twist Release 旋转释放 GXB2-ES642 Φ60		Double Extended/Flush button 双键凸平钮 Double Flush button 双键平钮 GXB2-EL8434	

Explanation of Type Designation(型号命名方式解释)

Example(示例):
GXB2 - ES4 4 2











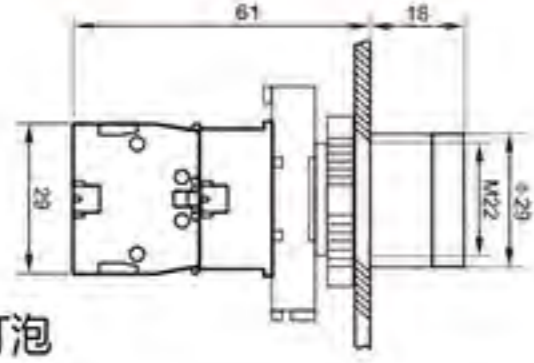

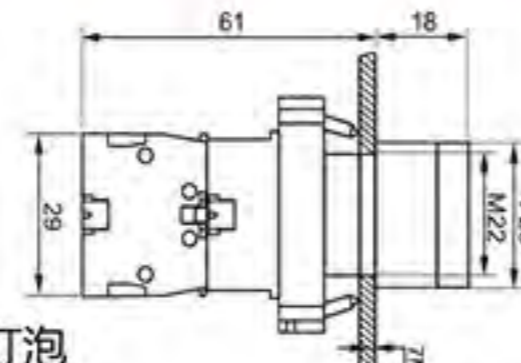

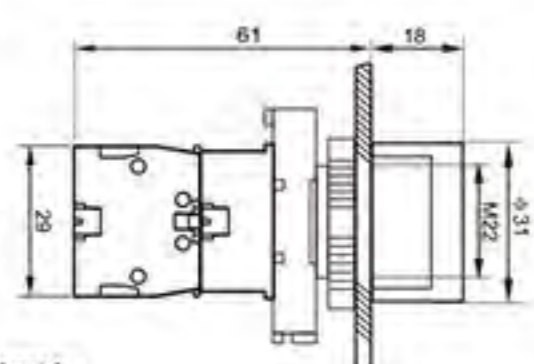
1 = 1NO 2 = 1NC 3 = 2NO 4 = 2NC 5 = 1NO+1NC	ES4 Twist Release Φ30 急停钮 (旋转释放, Φ30)	ES5 Twist Release Φ40 急停钮 (旋转释放, Φ40)	ES6 Twist Release Φ60 急停钮 (旋转释放, Φ60)
2 = Black(黑) 4 = Red(红)	ES1 Key Release Φ40 急停钮 (钥匙旋转释放, Φ40)	ET Pull Release Φ40 急停钮 (拉拔释放, Φ40)	

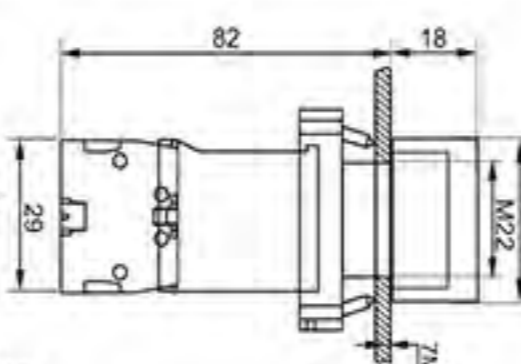
Example(示例):
GXB2 - EW 81 3 6 4

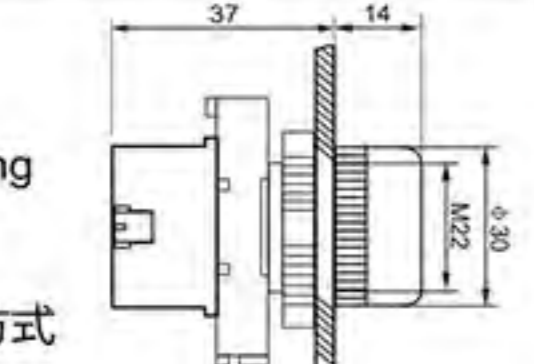
Color(Bottom) 下部按钮颜色	6 = Direct bulb included, 7 = Via integral resistance 直接插入式 阻容降压方式	4 = Via integral transformer 变压器降压方式
BA9S base BA9S 基座	Color(Upper) 上部按钮颜色	
EW = Illuminated (带灯型)	EA = Non-illuminated (不带灯型)	
	81=Double Flush button 双平型	82=Double Flush button(Mark) 双平型 (带符号)
	83=Extended/Flush button 凸平型	84=Extended/Flush button(Mark) 凸平型 (带符号)

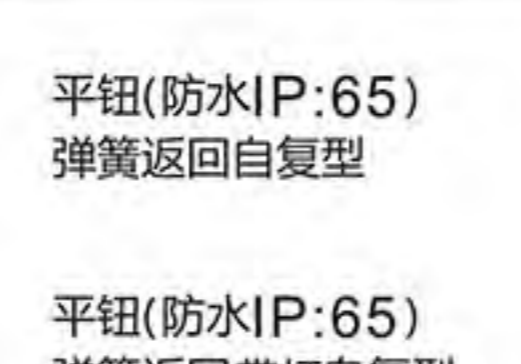

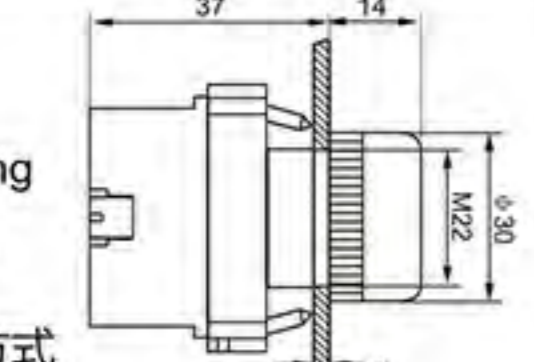

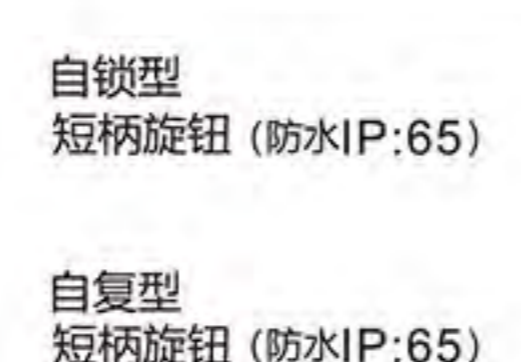



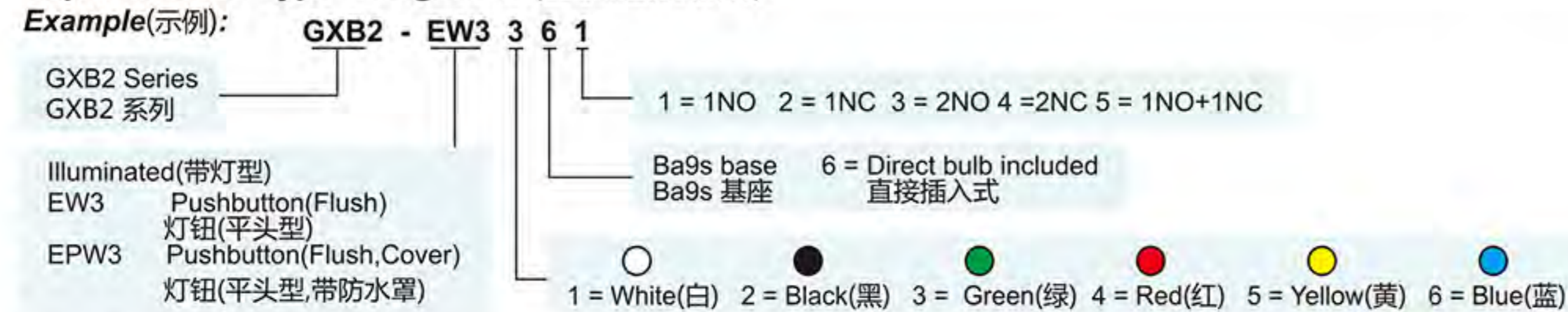

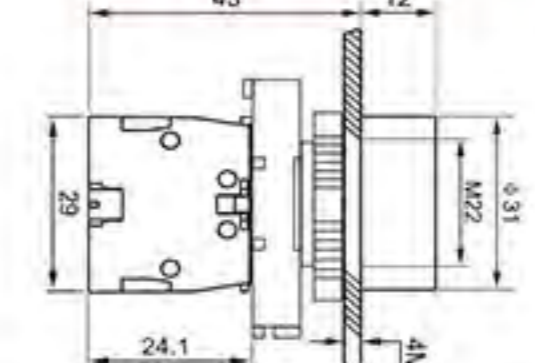

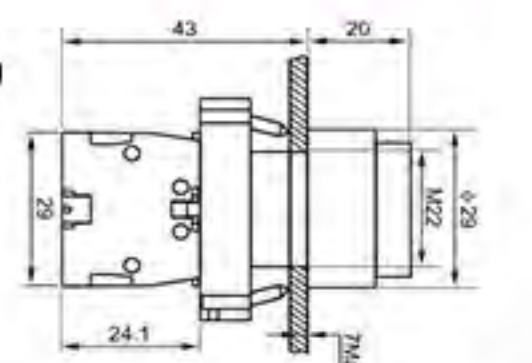

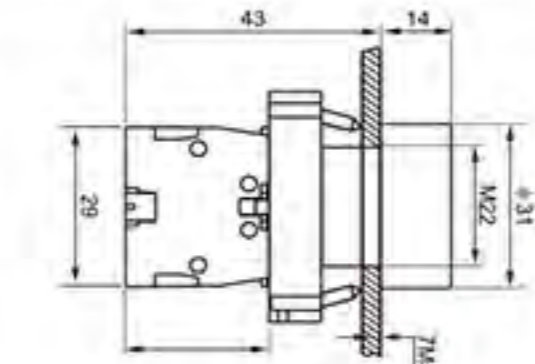

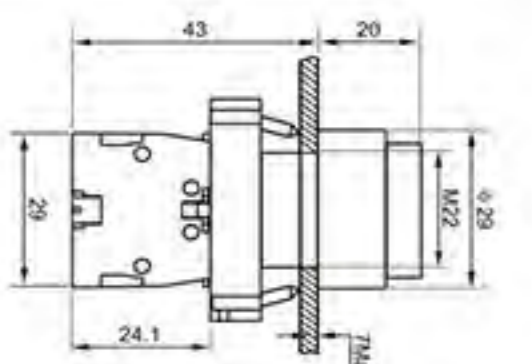

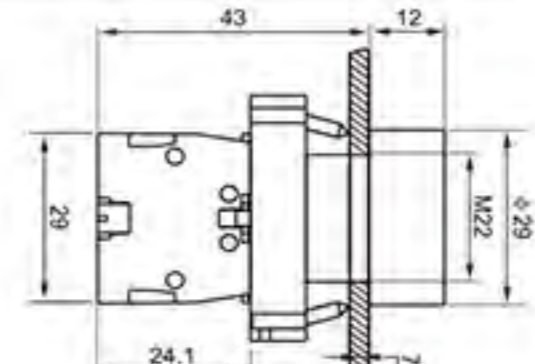
GXB2/GXB4按钮系列
GXB2/GXB4 push button series

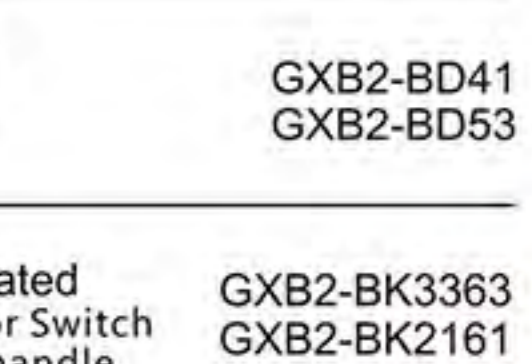
GXB2/GXB4按钮系列
GXB2/GXB4 push button series

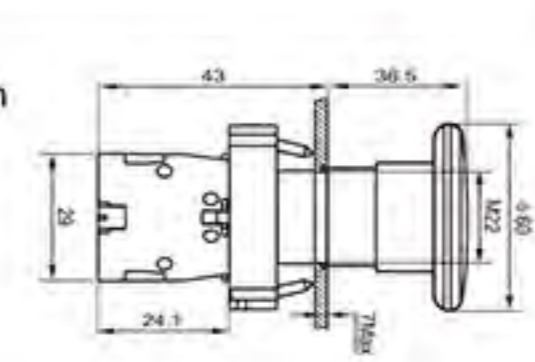
描述 Description	尺寸 Contour	描述 Description	尺寸 Contour
 <p>GXB2-EW3361 Direct Supply 12~240V Ba9s Bulb (LED/Neon) 直接插入方式 提供12~240V灯泡</p>		 <p>GXB2-BW3361 Direct Supply 12~240V Ba9s Bulb (LED/Neon) 直接插入方式 提供12~240V灯泡</p>	
 <p>GXB2-EPW3461 Direct Supply 12~240V Ba9s Bulb (LED/Neon) (with water-proof cover) IP65 直接插入方式 提供12~240V灯泡</p>		 <p>GXB2-BPW3462 Direct Supply 12~240V Ba9s Bulb (LED/Neon) (with water-proof cover) IP65 直接插入方式 提供12~240V灯泡</p>	
 <p>GXB2-EV66 Direct bulb included BA9s base fitting Neon (BA9S) LED 灯泡直接插入方式</p>		 <p>GXB2-BV64 Direct bulb included BA9s base fitting Neon (BA9S) LED 灯泡直接插入方式</p>	
 <p>GXB2-EV66 Direct bulb included BA9s base fitting Neon (BA9S) LED 灯泡直接插入方式</p>		 <p>GXB2-BV64 Direct bulb included BA9s base fitting Neon (BA9S) LED 灯泡直接插入方式</p>	

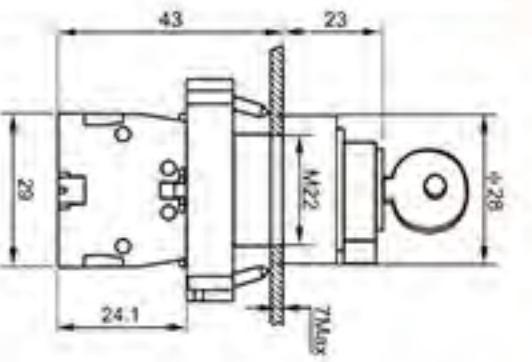
Explanation of Type Designation(型号命名方式解释)

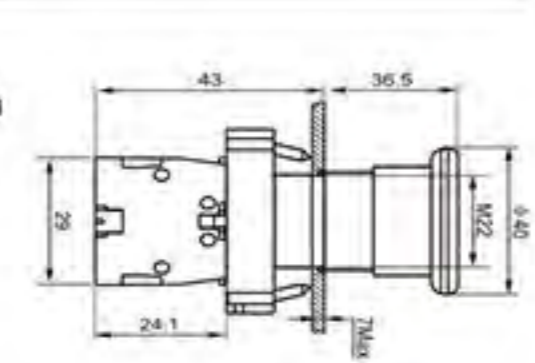

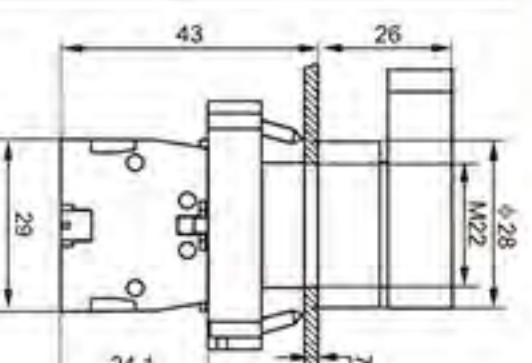
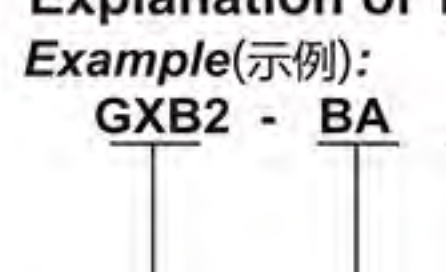
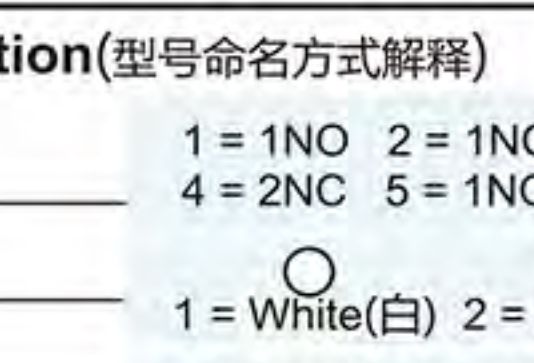
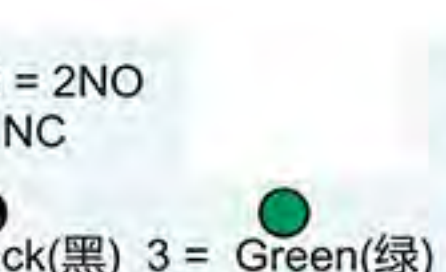
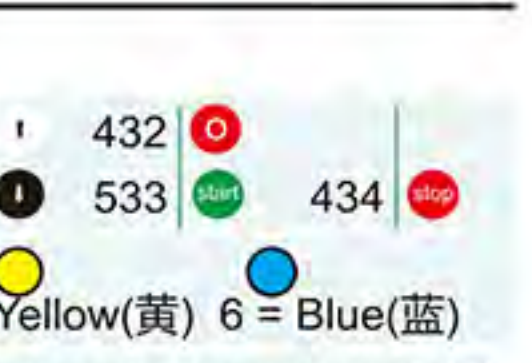
描述 Description	尺寸 Contour	描述 Description	尺寸 Contour
 <p>GXB2-BA42 Flush Button Momentary 平钮 弹簧返回 自复型</p>		 <p>GXB2-BL31 Extended button Momentary 凸钮 弹簧返回 自复型</p>	
 <p>GXB2-BP55 Flush Button Momentary (with water- proof cover) Unmarked IP 65 平钮(防水罩) 弹簧返回 自复型</p>		 <p>GXB2-BL3311 Extended button Momentary Marked 凸钮(带符号) 弹簧返回 自复型</p>	
 <p>GXB2-BA3341 Flush Button Momentary Marked 平钮(带符号) 弹簧返回 自复型</p>		 <p>GXB2-BD41 Selector Switch Short-handle 短柄旋钮</p>	
 <p>GXB2-BA3341 Flush Button Momentary Marked 平钮(带符号) 弹簧返回 自复型</p>		 <p>GXB2-BK3363 短柄旋钮 Illuminated Selector Switch (带灯型) Short-handle</p>	
 <p>GXB2-BR42 Φ60 Mushroom button Momentary 蘑菇头按钮 弹簧返回 自复型 Φ60</p>		 <p>GXB2-BG45 Key-operated 两/三档钥匙钮 (带灯型)</p>	
 <p>GXB2-BC42 Φ40 Mushroom button Momentary 蘑菇头按钮 弹簧返回 Φ40</p>		 <p>GXB2-BJ41 Selector Switch long-handle 长柄旋钮</p>	

Explanation of Type Designation(型号命名方式解释)



描述 Description	尺寸 Contour	描述 Description	尺寸 Contour
Twist Release 旋转释放 急停按钮 GXB2-BS442 Φ30		Double Flush Button Direct Supply 双键平按钮 直接插入方式 12~240V Ba9s Bulb (LED/Neon) 提供12~240V灯泡 GXB2-BW81364	
Twist Release 旋转释放 急停按钮 GXB2-BS542 Φ40		Extended/Flush Button Direct Supply 双键凸按钮 直接插入方式 12~240V Ba9s Bulb (LED/Neon) 提供12~240V灯泡 GXB2-BW84364	
Pull Release 拉拔释放 急停按钮 GXB2-BT42 Φ40		Double Flush button with waterproof cover Unmarked IP65 双键平按钮 带防水罩 GXB2-BA9234	
Key Release 钥匙旋转释放 急停按钮 GXB2-BS142 Φ40		Double Extended/flush button with waterproof cover Unmarked IP65 双键凸按钮 带防水罩 GXB2-BL9434	
Twist Release 旋转释放 GXB2-BS642 Φ60		Double Extended/Flush button 双键凸按钮 Double Flush button 双键平按钮 GXB2-BL8434	
Maintained 自锁型 GXB2-PA12		Maintained 自锁型 CS-2011	
Momentary 自复型 二方向 Two directions GXB2-PA22		Momentary 自复型 二方向 Two directions CS-201	
Maintained 自锁型 GXB2-PA14		Maintained 自锁型 CS-4022	
Momentary 自复型 四方向 Four directions GXB2-PA24		Momentary 自复型 四方向 Four directions CS-402	

Example(示例):
GXB2 - BW 81 3 6 4

- Color(Bottom) 下部按钮颜色
- BA9S base BA9S 基座
- Color(Upper) 上部按钮颜色
- BW = Illuminated (带灯型)
- BA = Non-illuminated (不带灯型)
- 6 = Direct bulb included, 7 = Via integral resistance, 4 = Via integral transformer
- 直接插入式 阻容降压方式 变压器降压方式

81=Double Flush button 双平型
82=Double Flush button(Mark) 双平型 (带符号)
83=Extended/Flush button 凸平型
84=Extended/Flush button(Mark) 凸平型 (带符号)

描述 Description	尺寸 Contour	描述 Description	尺寸 Contour
Flush button head GXB2-EA3 平按钮头		Mushroom Head Spring Return Momentary GXB2-EB4 蘑菇按钮头 弹簧返回 自复型 Φ30	
Extended button head GXB2-EL3 凸按钮头		Mushroom Head Spring Return Momentary GXB2-EC4 蘑菇按钮头 弹簧返回 自复型 Φ40	
Flush button head (with waterproof cover) GXB2-EP3 平按钮头 (带防水罩)		Mushroom Head Spring Return Momentary GXB2-ER4 蘑菇按钮头 弹簧返回 自复型 Φ60	
Flush button head marked GXB2-EA334 平按钮头 (带符号)		Mushroom Head Head Twist Release GXB2-ES44 蘑菇头型 急停按钮头 旋转释放 Φ30	
Extended button head marked GXB2-EL336 凸按钮头 (带符号)		Mushroom Head Head Twist Release GXB2-ES54 蘑菇头型 急停按钮头 旋转释放 Φ40	
Pilot light head with higher transparent protecting cover GXB2-EW33 灯按钮头 采用高透光率 护盖		Mushroom Head Head Twist Release GXB2-ES64 蘑菇头型 急停按钮头 旋转释放 Φ60	
Pilot light head GXB2-EV04 指示灯按钮头		Mushroom head Push-Pull GXB2-ET4 蘑菇头型 急停按钮头 拉拔释放 Φ40	
Selector switch head with lamp 2-position Maintained GXB2-EK23 带灯旋钮头 二位置自锁		Mushroom head return to release by key GXB2-ES14 钥匙急停按钮头 钥匙旋转释放 Φ40	
Selector switch head with lamp 3-position Maintained GXB2-EK33 带灯旋钮头 三位置自锁		Green button (Flush) Red button (Flush) IP40 (Waterproof cover)IP65 GXB2-EA813 绿键(平头型) 红键(平头型) (带防水罩)	
Selector Switch Short-handle GXB2-ED2 短柄旋钮头		Green button (Flush) Red button (Extended) IP40 (Waterproof cover)IP65 GXB2-EL833 绿键(平头型) 红键(凸头型) (带防水罩)	
Selector Switch long-handle GXB2-EJ2 长柄旋钮头		Green button (Flush) Red button (Flush) IP40 (Waterproof cover)IP65 GXB2-EW83 绿键(平头型) 红键(平头型) (带防水罩)	
Key-operated GXB2-EG2 钥匙按钮头		Green button (Flush) Red button (Extended) IP40 (Waterproof cover)IP65 GXB2-EW84 绿键(凸头型) 红键(凸头型) (带防水罩)	

GXB2/GXB4按钮系列
GXB2/GXB4 push button series

GXB2/GXB4按钮系列
GXB2/GXB4 push button series

描述 Description	尺寸 Contour	描述 Description	尺寸 Contour
GXB2-BA3 平钮头部 Flush button head		GXB2-BB4 蘑菇钮头部 弹簧返回 自复型 Mushroom Head Spring Return Momentary	
GXB2-BL3 凸钮头部 Extended button head		GXB2-BC4 蘑菇钮头部 弹簧返回 自复型 Mushroom Head Spring Return Momentary	
GXB2-BP5 平钮头部 (带防水罩) Flush button head (with water-proof cover)		GXB2-BR4 蘑菇钮头部 弹簧返回 自复型 Mushroom Head Spring Return Momentary	
GXB2-BA336 平钮头部 (带符号) Flush button head marked		GXB2-BS44 蘑菇头型 急停钮头部 旋转释放 Mushroom Head Twist Release	
GXB2-BL331 凸钮头部 (带符号) Extended button head marked		GXB2-BS54 蘑菇头型 急停钮头部 旋转释放 Mushroom Head Twist Release	
GXB2-BW33 灯钮头部 采用高透光率 护盖 Pilot light head with higher transparent protecting cover		GXB2-BS64 蘑菇头型 急停钮头部 旋转释放 Mushroom Head Twist Release	
GXB2-BV04 指示灯头部 Pilot light head		GXB2-BT4 蘑菇头型 急停钮头部 拉拔释放 Mushroom head Push-Pull	
GXB2-BK23 带灯旋钮头部 二位置自锁 Selector switch head with lamp 2-position Maintained		GXB2-BS14 钥匙急停头部 钥匙旋转释放 Mushroom head return to release by key	
GXB2-BK33 带灯旋钮头部 三位置自锁 Selector switch head with lamp 3-position Maintained		GXB2-BA8134H 绿键(平头型) 红键(平头型) (带防水罩) Green button (Flush) Red button (Flush) IP40 (Waterproof cover)IP65	
GXB2-BD2 短柄旋钮头部 Selector Switch Short-handle		GXB2-BL8334H 绿键(平头型) 红键(凸头型) (带防水罩) Green button (Flush) Red button (Extended) IP40 (Waterproof cover)IP65	
GXB2-BJ2 长柄旋钮头部 Selector Switch long-handle		GXB2-BW83 绿键(平头型) 红键(平头型) (带防水罩) Green button (Flush) Red button (Flush) IP40 (Waterproof cover)IP65	
GXB2-BG2 钥匙钮头部 Key-operated		GXB2-BW84 绿键(凸头型) 红键(凸头型) (带防水罩) Green button (Flush) Red button (Extended) IP40 (Waterproof cover)IP65	

描述 Description	尺寸 Contour	描述 Description	尺寸 Contour
Bottom seat of button with lamp Direct Type (LED/Neon) 全电压灯泡 直接插入式灯座	GXB2-EV6 (without push-shaft) 无推杆 GXB2-EW06 (with push-shaft) 有推杆	Bottom seat of button with lamp Direct Type (LED/Neon) 全电压灯泡 直接插入式灯座	(Without contact block) 无触点模块 GXB2-EW6 (With contact block) 带触点模块
Bottom seat of button with lamp Direct Type (LED/Neon) 全电压灯泡 直接插入式灯座	GXB2-BV6 (without push-shaft) 无推杆 GXB2-BW06 (with push-shaft) 有推杆	Bottom seat of button with lamp Direct Type (LED/Neon) 全电压灯泡 直接插入式灯座	(Without contact block) 无触点模块 GXB2-BW6 (With contact block) 带触点模块

Description(描述) | Contact(触点) | Type(型号) | Color(颜色) | Contour(尺寸)

Contact Block 触点模块	NO 3 4	GXB2-BE101		
Contact Block 触点模块	NC 1 2	GXB2-BE102		
Contact Block and Holder(Metal) 触点模块 加中座(金属)	NO 13 14	GXB2-BZ101		
Contact Block and Holder(Metal) 触点模块 加中座(金属)	NO + NO 13 14	GXB2-BZ103		
Contact Block and Holder(Metal) 触点模块 加中座(金属)	NO + NC 13 21 14 22	GXB2-BZ105		
Contact Block and Holder(Metal) 触点模块 加中座(金属)	NC 21 22	GXB2-BZ104		
Contact Block and Holder(Metal) 触点模块 加中座(金属)	NC 21 22	GXB2-BZ102		
Contact Block and Holder(Plastic) 触点模块 加中座(塑料)	NO 13 14	GXB2-EZ101		
Contact Block and Holder(Plastic) 触点模块 加中座(塑料)	NO + NO 13 14	GXB2-EZ103		
Contact Block and Holder(Plastic) 触点模块 加中座(塑料)	NO + NC 13 21 14 22	GXB2-EZ105		
Contact Block and Holder(Plastic) 触点模块 加中座(塑料)	NC 21 22	GXB2-EZ104		
Contact Block and Holder(Plastic) 触点模块 加中座(塑料)	NC 21 22	GXB2-EZ102		

GXB2/GXB4按钮系列
GXB2/GXB4 push button series

GXB2/GXB4按钮系列
GXB2/GXB4 push button series

描述 Description	尺寸 Contour	描述 Description	尺寸 Contour
Flush Button Momentary 平钮 弹簧返回 自复型 GXB4-EA42		Extended button Momentary 凸钮 弹簧返回 自复型 XB4-EL31	
Flush Button Momentary (with waterproof cover) 平钮(防水罩) 弹簧返回 自复型 GXB4-EP42		Extended button Momentary Marked 凸钮(带符号) 弹簧返回 自复型 XB4-EL3311	
Flush Button Momentary Marked 平钮(带符号) 弹簧返回 自复型 GXB4-EA4342		Selector Switch Short-handle 短柄旋钮 GXB4-ED42	
Mushroom button Momentary 蘑菇头按钮 弹簧返回 自复型 Φ60 GXB4-ER21		Illuminated Selector Switch Short-handle 带灯短柄旋钮 GXB4-BK2161	
Mushroom button Momentary 蘑菇头按钮 弹簧返回 Φ40 GXB4-EC21		Selector Switch long-handle 长柄旋钮 GXB4-EJ41	
		Selector Switch long-handle 长柄旋钮 GXB4-EJ53	
		Key-operated 钥匙钮 GXB4-EG45	
		Key-operated 钥匙钮 GXB4-EG53	

Explanation of Type Designation (型号命名方式解释)

Example (示例):
GXB4 - EA 3 1

GXB4 Series
GXB4 系列

EA Flush Pushbutton (Momentary) 平钮 (自复型)
EL Extended Pushbutton (Momentary) 凸钮 (自复型)
EP Flush Pushbutton (Cover) (Momentary) 平钮 (自复型, 带防水罩)

EC Pushbutton, Mushroom (Momentary, Φ40) 蘑菇头按钮 (自复型, Φ40)
ER Pushbutton, Mushroom (Momentary, Φ60) 蘑菇头按钮 (自复型, Φ60)

1 = 1NO 2 = 1NC 3 = 2NO 4 = 2NC 5 = 1NO+1NC

1 = White (白) 2 = Black (黑) 3 = Green (绿) 4 = Red (红) 5 = Yellow (黄) 6 = Blue (蓝)

2: 二位置自锁 2-position (Maintained)
3: 三位置自锁 3-position (Maintained)
4: 二位置由右至左自复 2-position (Momentary, R to L)
5: 三位置由右至中和由左至中自复 3-position (Momentary, R to C & L to C)
6: 三位置由右至中自复 3-position (Momentary, R to C)
7: 三位置由左至中自复 3-position (Momentary, L to C)

D: 选择开关 (短柄) Selector Switch (Short-handle)
J: 选择开关 (长柄) Selector Switch (long-handle)
G: 钥匙开关 Key-operated

描述 Description	尺寸 Contour	描述 Description	尺寸 Contour
Twist Release 旋转释放 急停钮 GXB4-ES542		1 Flush green button 1 Flush red button IP40 GXB4-EW82364	
Key Release 钥匙旋转释放 急停钮 GXB4-ES142		1 Flush green button 1 Extended red button IP40 GXB4-EW84364	
Pull Release 拉拔释放 急停钮 GXB4-ET42		Double Flush button with waterproof cover Unmarked IP65 双键平钮 带防水罩 GXB4-EA9134	
Direct bulb included BA9s base fitting Neon (BA9S) LED 灯泡直接插入方式 GXB4-EV63		Double Extended/flush button with waterproof cover Unmarked IP65 双键凸平钮 带防水罩 GXB4-EL9334	
提供 Direct Supply 12~240V 灯泡 Ba9s Bulb 直接插入方式 (LED/Neon) GXB4-EW3565		Double Extended/Flush button 双键凸平钮 GXB4-EA8234	
提供 Direct Supply 12~240V 灯泡 Ba9s Bulb 直接插入方式 (LED/Neon) GXB4-EPW3565		Double Flush button 双键平钮 GXB4-EL8434	

Explanation of Type Designation (型号命名方式解释)

Example (示例):
GXB4 - ES1 4 2

GXB4 Series
GXB4 系列

ES1 Key Release Φ40 急停钮 (钥匙旋转释放, Φ40)
ES5 Twist Release Φ40 急停钮 (旋转释放, Φ40)
ET Pull Release Φ40 急停钮 (拉拔释放, Φ40)

1 = 1NO 2 = 1NC 3 = 2NO 4 = 2NC 5 = 1NO+1NC

2 = Black (黑) 4 = Red (红)

Color (Bottom) 下部按钮颜色
BA9S base BA9S 基座
Color (Upper) 上部按钮颜色

6 = Direct bulb included, 7 = Via integral resistance 直接插入式 阻容降压方式
4 = Via integral transformer 变压器降压方式

EW = Illuminated (带灯型)
EA = Non-illuminated (不带灯型)

81 = Double Flush button 双平型
82 = Double Flush button (Mark) 双平型 (带符号)
83 = Extended/Flush button 凸平型
84 = Extended/Flush button (Mark) 凸平型 (带符号)

GXB2/GXB4按钮系列
GXB2/GXB4 push button series

GXB2/GXB4按钮系列
GXB2/GXB4 push button series

描述 Description	尺寸 Contour	描述 Description	尺寸 Contour
GXB4-BA31 Flush Button Spring Return Momentary 平钮 弹簧返回 自复型		GXB4-BL42 Extended button Momentary 凸钮 弹簧返回 自复型	
GXB4-BP31 Flush Button Momentary (with water-proof cover) Unmarked IP 65 平钮(防水罩) 弹簧返回 自复型		GXB4-BL4322 Extended button Momentary Marked 凸钮(带符号) 弹簧返回 自复型	
GXB4-BL4322 Momentary Spring Return Marked 平钮(带符号) 弹簧返回 自复型		GXB4-BD53 Selector Switch Short-handle 短柄旋钮	
GXB4-BR42 Φ60 Pushbutton, Mushroom Spring Return Momentary 蘑菇头按钮 弹簧返回 自复型		GXB4-BK2161 Illuminated Selector Switch Short-handle 带灯短柄旋钮	
GXB4-BC42 Φ40 Pushbutton, Mushroom Spring Return Momentary 蘑菇头按钮 弹簧返回 自复型		GXB4-BJ41 Selector Switch long-handle 长柄旋钮	
		GXB4-BG41 Key-operated 钥匙钮	
		GXB4-BG53 Key-operated 钥匙钮	

Explanation of Type Designation (型号命名方式解释)

Example (示例):
GX B4 - BA 3 1

1 = 1NO 2 = 1NC 3 = 2NO
4 = 2NC 5 = 1NO+1NC

331 (Green) 334 (Black) 432 (Red)
336 (Blue) 335 (Yellow) 533 (White) 434 (Blue)

1 = White(白) 2 = Black(黑) 3 = Green(绿) 4 = Red(红) 5 = Yellow(黄) 6 = Blue(蓝)

BA Flush Pushbutton(Momentary) BC Pushbutton, Mushroom(Momentary, Φ40)
平钮(自复型) 蘑菇头按钮(自复型, Φ40)
BL Extended Pushbutton(Momentary) BR Pushbutton, Mushroom(Momentary, Φ60)
凸钮(自复型) 蘑菇头按钮(自复型, Φ60)
BP Flush Pushbutton(Cover)(Momentary) 平钮(自复型, 带防水罩)

Example (示例):
GX B4 - BD 3 1

1 = 1NO 2 = 1NC 3 = 2NO
4 = 2NC 5 = 1NO+1NC

2: 二位置自锁 4: 二位置由右至左自复
2-position (Maintained) 2-position (Momentary, R to L)
3: 三位置自锁 5: 三位置由右至中和由左至中自复
3-position (Maintained) 3-position (Momentary, R to C & L to C)
6: 三位置由右至中自复 7: 三位置由左至中自复
3-position (Momentary, R to C) 3-position (Momentary, L to C)

D: 选择开关(短柄) J: 选择开关(长柄)
Selector Switch(Short-handle) Selector Switch(long-handle)
G: 钥匙开关 Key-operated

描述 Description	尺寸 Contour	描述 Description	尺寸 Contour
GXB4-BS542 Twist Release 旋转释放 急停钮		GXB4-BW82364 Illuminated Double Flush button IP40 带灯型双键平钮	
GXB4-BS142 Key Release 钥匙旋转释放 急停钮		GXB4-BW84364 Illuminated Double Extended/Flush Button IP40 带灯型双键凸平钮	
GXB4-BT42 Pull Release 拉拔释放 急停钮		GXB4-BA9234 Double Flush button with waterproof cover Unmarked IP65 双键平钮 带防水罩	
GXB4-BV63 Direct bulb included BA9s base fitting Neon (BA9S) LED 灯泡直接插入		GXB4-BL9334H Double Extended/flush button with waterproof cover Unmarked IP65 双键凸平钮 带防水罩	
GXB4-BV73 Integrated lamp block LED 一体式LED灯座		GXB4-BA8124 Double Extended/Flush button 双键凸平钮	
GXB4-BW3365 提供 Direct Supply 12~240V 灯泡 Ba9s Bulb 直接插入方式 (LED/Neon)		GXB4-BL8324 Double Flush button 双键平钮	
GXB4-BPW3365 提供 Direct Supply 12~240V 灯泡 Ba9s Bulb 直接插入方式 (LED/Neon)			

Explanation of Type Designation (型号命名方式解释)

Example (示例):
GX B4 - BV 6 1

1 = White(白) 2 = Black(黑) 3 = Green(绿) 4 = Red(红) 5 = Yellow(黄) 6 = Blue(蓝)

6 = Direct bulb included 灯泡直接插入 7 = Integrated lamp block 一体式LED灯座

























BV Pilot Lights 指示灯
BW3 Pushbutton(Flush) 平钮
BPW3 Pushbutton(Flush, Cover) 平钮(带防水罩)

Example (示例):
GX B4 - EW 81 3 6 4

Color(Bottom) 下部按钮颜色
BA9S base BA9S 基座 6 = Direct bulb included, 7 = Via integral resistance 直接插入式 阻容降压方式
Color(Upper) 上部按钮颜色
EW = Illuminated (带灯型) 81=Double Flush button 双平型
EA = Non-illuminated (不带灯型) 82=Double Flush button(Mark) 双平型(带符号)
83=Extended/Flush button 凸平型
84=Extended/Flush button(Mark) 凸平型(带符号)

GX B2/GX B4按钮系列

GX B2/GX B4按钮系列

描述 Description	尺寸 Contour	描述 Description	尺寸 Contour
 GXB4-EA4 平钮头部	Flush button head	 Double Flush button 双平型	
 GXB4-EL3 凸钮头部	Extended button head	 Double Extended/Flush button 凸平型	
 GXB4-EP3 平钮头部 (带防水罩)	Flush button head (with waterproof cover)	 GXB4-EG2 钥匙钮头部	Key-operated 
 GXB4-EA434 平钮头部 (带符号)	Flush button head marked	 GXB4-BA3 平钮头部	Flush button head
 GXB4-EL336 凸钮头部 (带符号)	Extended button head marked	 GXB4-BL4 凸钮头部	Extended button head
 GXB4-EW35 灯钮头部 采用高透光率护盖	Pilot light head with higher transparent protecting cover	 GXB4-BP4 平钮头部 (带防水罩)	Flush button head (with waterproof cover)
 GXB4-EV06 指示灯头部	Pilot light head	 GXB4-BA533 平钮头部 (带符号)	Flush button head marked
 GXB4-BC2 $\Phi 40$	Return to release selector switch 旋转急停钮头部 Push-Pull 推拉式急停钮头部 Spring return 自复蘑菇钮头部	 GXB4-BL432 凸钮头部 (带符号)	Extended button head marked
 GXB4-ED5 短柄旋钮头部	Selector Switch Short-handle	 GXB4-BS54 $\Phi 40$	Return to release selector switch 旋转急停钮头部 Push-Pull 推拉式急停钮头部 Spring return 蘑菇钮头部
 GXB4-EJ3 长柄旋钮头部	Selector Switch long-handle	 GXB4-BD2 短柄旋钮头部	Selector Switch Short-handle
 GXB4-ES14 钥匙急停钮头部	Mushroom head return to release by key	 GXB4-BJ2 长柄旋钮头部	Selector Switch long-handle

描述 Description	尺寸 Contour	描述 Description	尺寸 Contour
 GXB4-BW33 灯钮头部 采用高透光率护盖	Pilot light head with higher transparent protecting cover	 Double Flush button 双平型	
 GXB4-BV03 指示灯头部	Pilot light head	 Double Extended/Flush button 凸平型	
 GXB4-BS14 钥匙急停钮头部	Mushroom head return to release by key	 双平型 双平型 (带符号) 凸平型 凸平型 (带符号)	Double Flush button Double flush button Mark Extended/Flush button Extended/Flush button Mark
 GXB4-BG2 钥匙钮头部	Key-operated		
描述 Photo	描述 Description	描述 Photo	描述 Description
 Contact block 常开触点模块	N/O GXB4-BE101	 Contact block 常闭触点模块	N/C GXB4-BE102
 Plastic bracket 塑料中座	GXB4-E	 Metal bracket 金属中座	GXB4-B
 Contact block with lamp Direct Type LED 一体式灯座	GXB4-EV7	 Contact block with lamp Direct Type Neon LED (BA9S) BA9S灯座	GXB4-EV6
 Plastic bracket + Contact block 塑料中座加常开触点模块	N/O GXB4-EZ101	 Plastic bracket + Contact block 塑料中座加常闭触点模块	N/C GXB4-EZ102
 Plastic bracket + 2 contact block 塑料中座加两常开触点模块	N/O+N/O GXB4-EZ103	 Plastic bracket + 2 contact block 塑料中座加常开触点模块和常闭触点模块	N/O+N/C GXB4-EZ105
 Metal bracket + Contact block 金属中座加常开触点模块	N/O GXB4-BZ101	 Metal bracket + Contact block 金属中座加常闭触点模块	N/C GXB4-BZ102
 Metal bracket + 2 contact block 金属中座加两常开触点模块	N/O+N/O GXB4-BZ103	 Metal bracket + 2 contact block 金属中座加常开触点模块和常闭触点模块	N/O+N/C GXB4-BZ105

GXB2/GXB4按钮系列
GXB2/GXB4 push button series

GXB2/GXB4按钮系列
GXB2/GXB4 push button series

型号及含义 MODEL AND MEANING

LAY7-1 2 3 / 4 5

设计序号 Design serial number
按钮开关型号 Push button code

1 表示常开触头 NO contact

2 表示常闭触头 NC contact

4 表示罩面颜色 Color of shade surface

红	绿	黄	蓝	白	黑
R	G	Y	B	W	K

5 电压(Voltage)

21-DC.AC 6V	26-DC.AC 110V
22-DC.AC 12V	27-DC.AC 127V
23-DC.AC 24V	28-DC 220V
24-DC.AC 36V	31-AC 220V
25-DC.AC 48V	32-AC 380V

使用环境条件 WORKING ENVIRONMENT

周围空气温度 -25℃ ~ +40℃
Ambient air temperature -25℃ ~ +40℃.
海拔高度 ≤ 2000m; Altitude: ≤ 2000m.
空气相对湿度 ≤ 90%; Relative air humidity: ≤ 90%.
污染等级 3级; Pollution degree: class 3.
防护等级 IP40/IP65; Protection degree: IP40/IP65.

主要技术参数 MAIN TECHNICAL PARAMETER

开关额定值 Rated value of switch: AC-15 36V/10A 110V/10A 220V/5A 380V/2.7A 660V/1.8A
DC-13 24V/4A 48V/4A 110V/2A 220V/1A 440V/0.6A.

约定发热电流 Conventional thermal current: Ith 10A.

触点电阻 Contact resistance: ≤ 50mΩ

绝缘电阻 Insulation resistance: ≥ 10MΩ

机械寿命 Mechanical durability: 一般按钮 Common push-button ≥ 100 × 10⁴次 times; 旋钮 Selector button ≥ 30 × 10⁴次 times.
钥匙按钮 Key push-button ≥ 5 × 10⁴次 times; 紧急按钮 Emergency push-button ≥ 5 × 10⁴次 times.

3 表示机械形式 Mechanical form

字母 letter	含义 Implication
BN	平按钮 Flush push button
D	带灯按钮 Illuminated push button
Z	自锁按钮 Maintained push button
DZ	带灯自锁按钮 Illuminated Maintained push button
M	蘑菇按钮 Mushroom push button
MD	带灯蘑菇按钮 Illuminated Mushroom button
MZS	自锁蘑菇按钮 Maintained Mushroom button
MDZS	带灯自锁蘑菇按钮 Illuminated Maintained Mushroom button
ZS	急停按钮 Emergency stop button
DZS	急停带灯按钮 Illuminated emergency stop button
Y/2	二位钥匙按钮 2-Position keylock selector
Y/3	三位钥匙按钮 3-Position keylock selector
X/2	短柄二档旋钮 2-Position short lever selector
XD/2	带灯短柄二档旋钮 Illuminated 2-Position short lever selector
X/3	短柄三档旋钮 3-Position short lever selector
XD/3	带灯三档旋钮 Illuminated 3-Position short lever selector
XB/2	长柄二档旋钮 2-Position long lever selector
XB/3	长柄三档旋钮 3-Position long lever selector
GN	高位按钮 Extended push button
DN	带灯高位按钮 Illuminated extended push button
GNZS	自锁高位按钮 Maintained extended push button
DNZS	带灯自锁高位按钮 Illuminated Maintained extended push button

描述 Description

尺寸 Contour

描述 Description

尺寸 Contour



自复型 Momentary
LAY7-01BN

自锁型 Maintained
LAY7-01Z

带灯自复型 Momentary Illuminated
LAY7-10D



自复型 Momentary
LAY7-01GN

自复型 Momentary
LAY7-01DN

带灯自锁型 Maintained Illuminated
LAY7-10DNZS



两档短柄旋钮 Selector Switch
LAY7-01X/2 Short-handle 2-Position

带灯旋钮 Selector Switch
LAY7-01XD/2 Short-handle Illuminated



三档短柄旋钮 Selector Switch
LAY7-11X/3 Short-handle 3-Position

带灯旋钮 Selector Switch
LAY7-11XD/3 Short-handle Illuminated



两档长柄旋钮 Selector Switch
LAY7-01XB/2 long-handle 2-Position

三档长柄旋钮 Selector Switch
LAY7-11XB/3 long-handle 3-Position



自复型 Momentary
LAY7-01M

自锁型 Maintained
LAY7-01MZS

带灯自复型 Momentary Illuminated
LAY7-01MD

带灯自锁型 Maintained Illuminated
LA115-A5-01MDZS



急停按钮 Emergency stop
不带灯型 Non-illuminated
LAY7-11ZS



急停按钮 Emergency stop
带灯型 illuminated
LAY7-11DZS











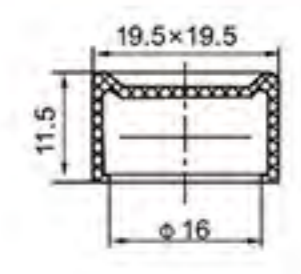

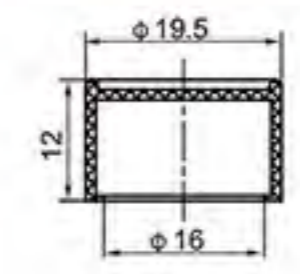

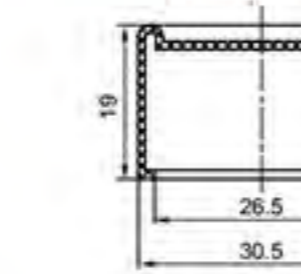

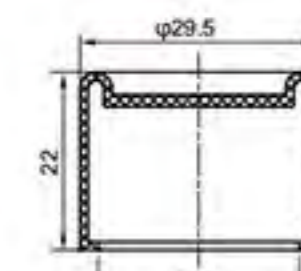
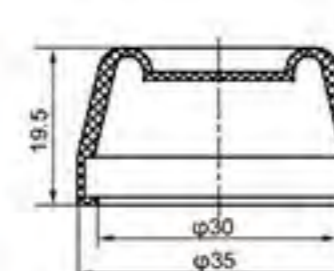

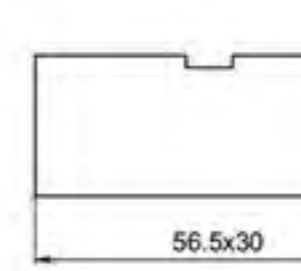

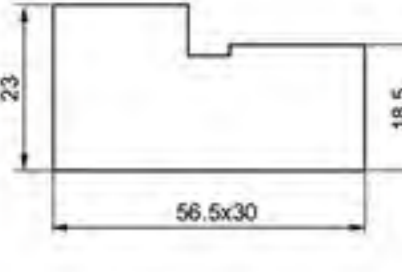

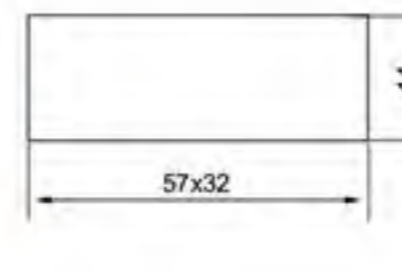

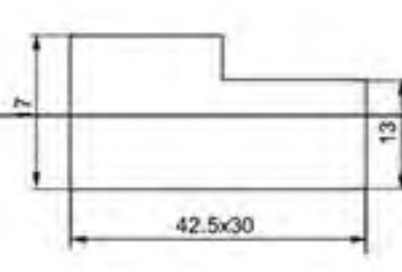
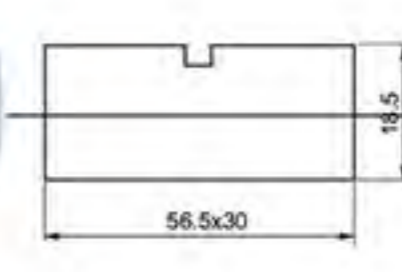

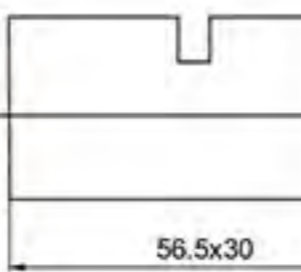

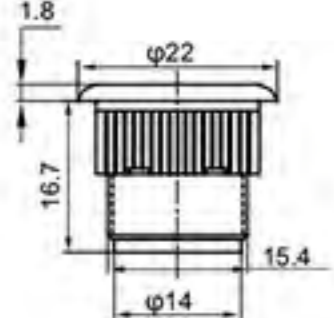

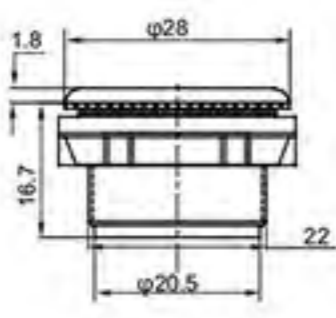

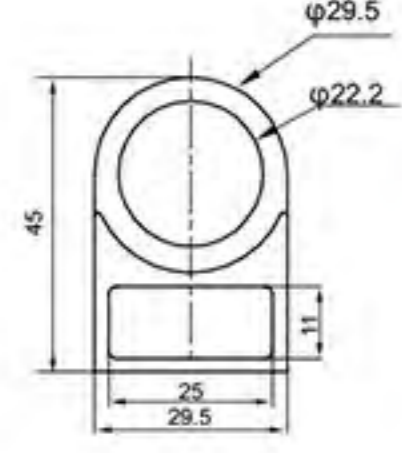

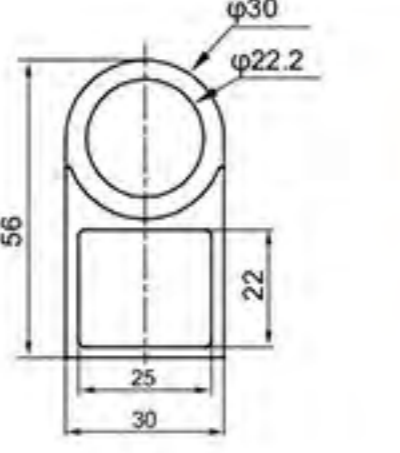

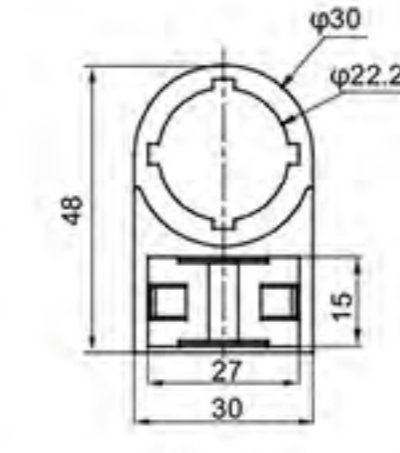
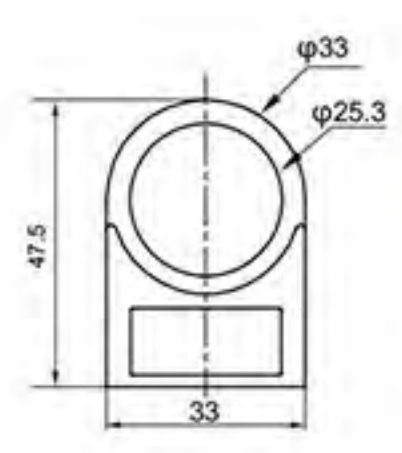

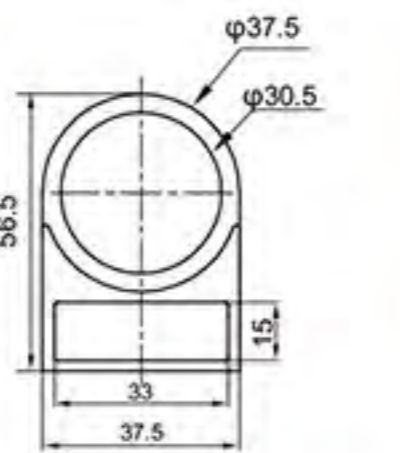

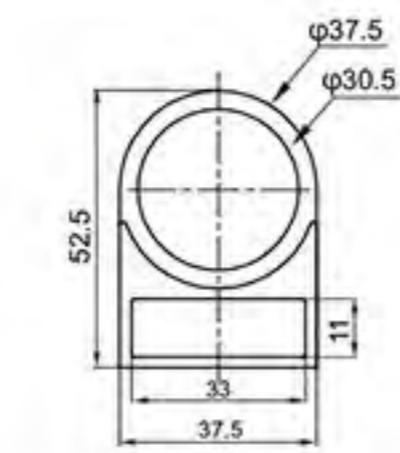



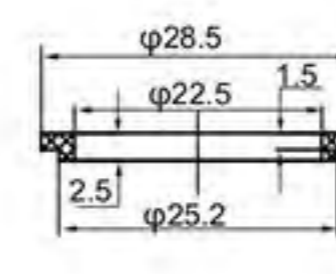

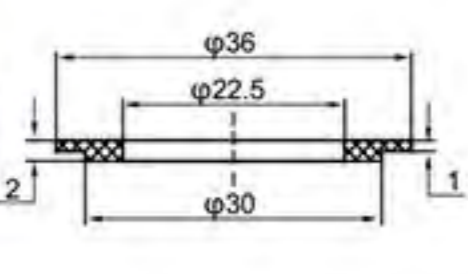

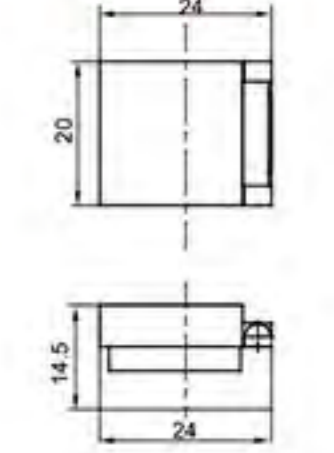

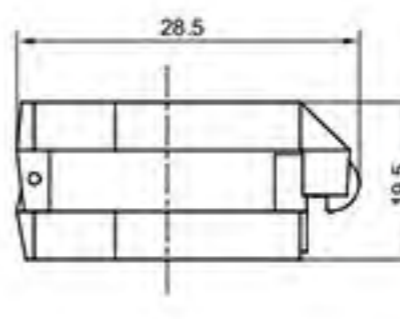

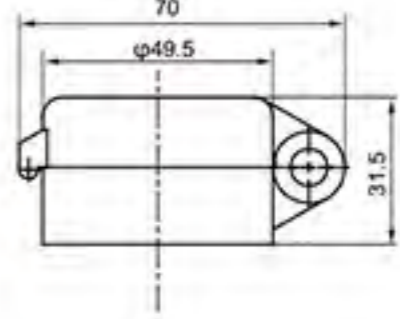

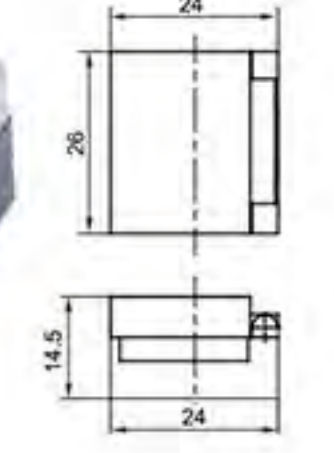

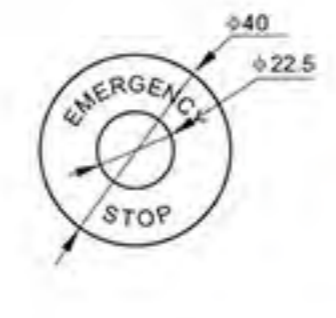

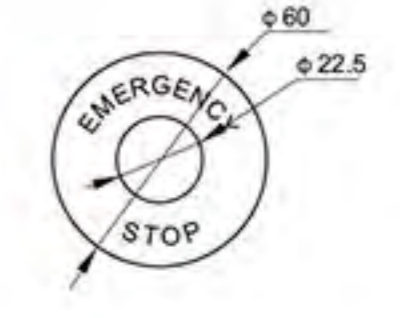

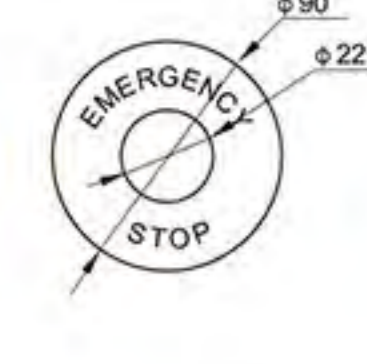

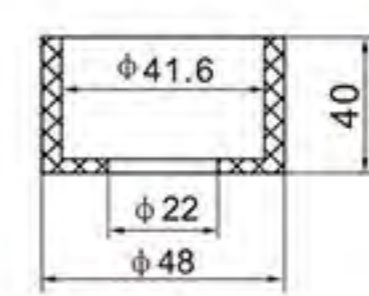

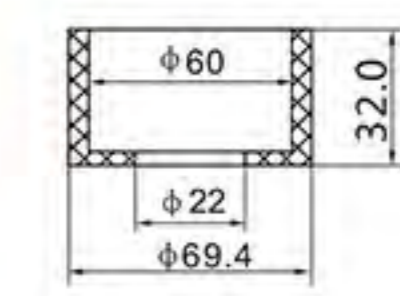

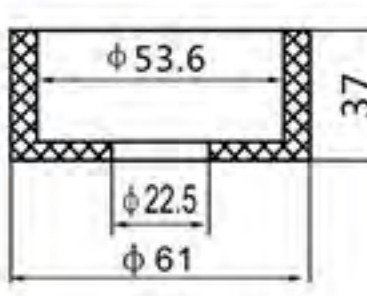
两档钥匙按钮 Key-operated
LAY7-01Y/2 2-Position

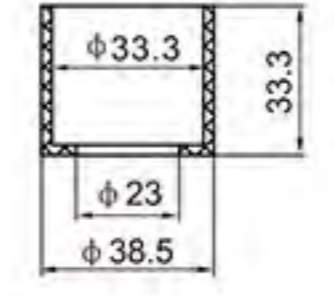
两档钥匙按钮 Key-operated
LAY7-11Y/3 3-Position

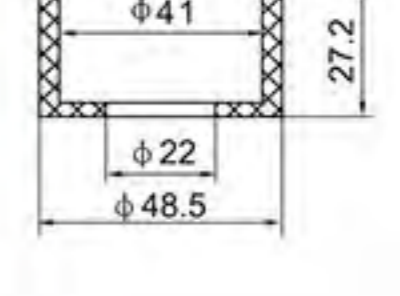
样式 Photo | 图纸 Contour | 样式 Photo | 图纸 Contour | 样式 Photo | 图纸 Contour

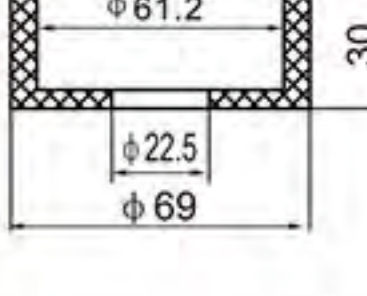
样式 Photo | 图纸 Contour | 样式 Photo | 图纸 Contour | 样式 Photo | 图纸 Contour

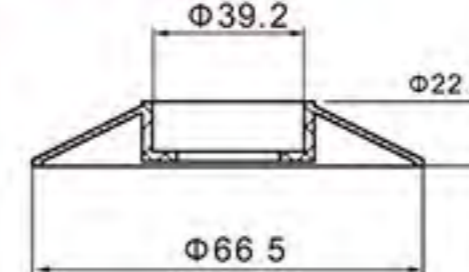
					
GXB2-PE16F		GXB2-PE16A		GXB2-PE22A	
					
GXB2-PE22W		GXB2-PE30C		GXB2-PE22B	
					
GXB2-PE22BH		GXB2-PE22F		GXB2-PE22F	
					
GXB2-PE22FH		GXB2-PE22CF		GXB2-PE22CHF	
					
GXB2-PB16		GXB2-PB22		GXB2-PB30	
					
GXB2-EH2201		GXB2-EH2208		GXB2-EH2204	
					
GXB2-EH2206		GXB2-EH2225		GXB2-EH2230	

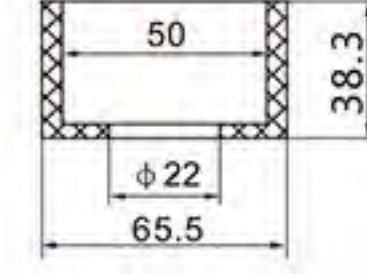
					
GXB2-ER25 (AD22-ER25)		GXB2-ER30 (AD22-ER30)		GXB2-ZB16F	
					
GXB2-EB22P		GXB2-EB40P		GXB2-ZB16CF	
					
GXB2-ER40		GXB2-ER60		GXB2-ER90	
					
GXB2-EC2		GXB2-EC3		GXB2-EC4	
					
GXB2-EB30		GXB2-EB40		GXB2-EB60	
					
型号(Type) : GXB2-ER66		型号(Type) : GXB2-EC5-1	型号(Type) : GXB2-EC5		

按钮附件
parts of push button series

按钮附件
parts of push button series

选型说明 TYPE AND MEANING

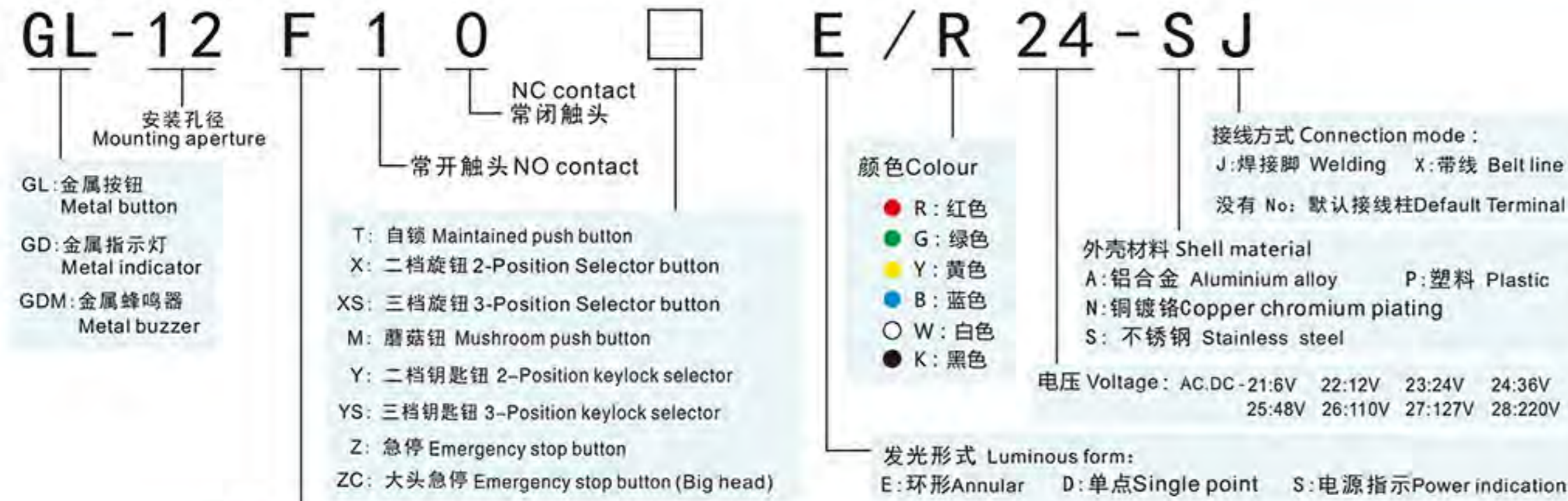

- 形状 Shape:
- B: 球形(长壳体) Spherical (Long shell)
 - BA: 球形(短壳体) Spherical (Short shell)
 - BC: 大头球形 Spherical (Big head)
 - BE: 圆外套球形 Spherical (Round coat)
 - BF: 方外套球形 Spherical (Square coat)
 - BP: 半塑料球形 Spherical (Half plastic)
 - F: 平钮(长壳体) Flat button (Long shell)
 - FA: 平钮(短壳体) Flat button (Short shell)
 - FC: 大头平钮 Flat button (Big head)
 - FE: 圆外套平钮 Flat button (Round coat)
 - FF: 方外套平钮 Flat button (Square coat)
 - H: 凸钮(长壳体) High button (Long shell)
 - HA: 凸钮(短壳体) High button (Short shell)
 - HE: 圆外套凸钮 High button (Round coat)
 - HF: 方外套凸钮 High button (Square coat)

产品样式(描述) Product style (description)	型号 Model	产品样式(描述) Product style (description)	型号 Model
安装孔径 6mm Mounting aperture	24V绿色 G 铜镀铬 Copper chromium plating	GD-6F/G23-NX	24V蓝色 B 铜镀铬 Copper chromium plating
	24V黄色 Y 不锈钢 Stainless steel	GD-6F/Y23-SX	24V黄色 Y 不锈钢 Stainless steel
安装孔径 8mm Mounting aperture	24V红色 R 铜镀铬 Copper chromium plating	GD-8F/R23--NJ	24V白色 W 铜镀铬 Copper chromium plating
	24V红色 R 不锈钢 Stainless steel	GD-8F/R23--SJ	24V黄色 Y 不锈钢 Stainless steel
安装孔径 12mm Mounting aperture	24V绿色 G 铜镀铬 Copper chromium plating	GD-12F/G23-N	24V蜂鸣器 Metal buzzer 铜镀铬 Copper chromium plating
	24V白色 W 不锈钢 Stainless steel	GD-12F/W23-S	24V蜂鸣器 Metal buzzer 不锈钢 Stainless steel
安装孔径 16mm Mounting aperture	24V绿色 G 铜镀铬 Copper chromium plating	GD-16F/G23-N	24V蜂鸣器 Metal buzzer 铜镀铬 Copper chromium plating
	24V蓝色 B 不锈钢 Stainless steel	GD-16F/B23-S	24V蜂鸣器 Metal buzzer 不锈钢 Stainless steel
安装孔径 19mm Mounting aperture	24V红色 R 铜镀铬 Copper chromium plating	GD-19F/R23--N	24V蜂鸣器 Metal buzzer 铜镀铬 Copper chromium plating
	24V黄色 Y 不锈钢 Stainless steel	GD-19F/Y23-S	24V蜂鸣器 Metal buzzer 不锈钢 Stainless steel
安装孔径 22mm Mounting aperture	24V绿色 G 铜镀铬 Copper chromium plating	GD-22F/G23-N	24V蜂鸣器 Metal buzzer 铜镀铬 Copper chromium plating
	24V黄色 Y 不锈钢 Stainless steel	GD-22F/Y23-S	24V蜂鸣器 Metal buzzer 不锈钢 Stainless steel

产品样式 Product style	描述 Description	外壳材料 Shell material	型号 Model
安装孔径 12mm Mounting aperture	1NO 自复钮 Momentary	大头球形/接线柱 Spherical (Big head)/ Terminal	铜镀铬 Copper chromium plating GL-12BC10-N 不锈钢 Stainless steel GL-12BC10-S
	1NO 自复钮 Momentary	大头球形/焊接脚 Spherical (Big head)/ Welding	铜镀铬 Copper chromium plating GL-12BC10-NJ 不锈钢 Stainless steel GL-12BC10-SJ
	1NO+1NC 自复钮 Momentary	大头球形/焊接脚 Spherical (Big head)/ Welding	铜镀铬 Copper chromium plating GL-12BC11-NJ 不锈钢 Stainless steel GL-12BC11-SJ
安装孔径 12mm Mounting aperture	1NO 自复钮 Momentary	大头平钮/接线柱 Flat button (Big head)/ Terminal	铜镀铬 Copper chromium plating GL-12FC10-N 不锈钢 Stainless steel GL-12FC10-S
	1NO 自复钮 Momentary	大头球形/焊接脚 Flat button (Big head)/ Welding	铜镀铬 Copper chromium plating GL-12FC10-NJ 不锈钢 Stainless steel GL-12FC10-SJ
	1NO+1NC 自复钮 Momentary	大头球形/焊接脚 Flat button (Big head)/ Welding	铜镀铬 Copper chromium plating GL-12FC11-NJ 不锈钢 Stainless steel GL-12FC11-SJ
安装孔径 12mm Mounting aperture	1NO 自复钮 Momentary	大头球形/接线柱 Spherical (Big head)/ Terminal	铜镀铬 Copper chromium plating GL-12BP10-N 不锈钢 Stainless steel GL-12BP10-S
	1NO 自复钮 Momentary	大头球形/焊接脚 Spherical (Big head)/ Welding	铜镀铬 Copper chromium plating GL-12BP10-NJ 不锈钢 Stainless steel GL-12BP10-SJ
	1NO+1NC 自复钮 Momentary	大头球形/焊接脚 Spherical (Big head)/ Welding	铜镀铬 Copper chromium plating GL-12BP11-NJ 不锈钢 Stainless steel GL-12BP11-SJ
安装孔径 12mm Mounting aperture	1NO 自复钮 Momentary	平钮/焊接脚 Flat button/Welding	铜镀铬 Copper chromium plating GL-12F10-NJ 不锈钢 Stainless steel GL-12F10-SJ
	1NO 自锁钮 Maintained	平钮/焊接脚 Flat button/Welding	铜镀铬 Copper chromium plating GL-12F10T-NJ 不锈钢 Stainless steel GL-12F10T-SJ
安装孔径 12mm Mounting aperture	1NO 自复钮 Momentary	凸钮/焊接脚 High button/Welding	铜镀铬 Copper chromium plating GL-12H10-NJ 不锈钢 Stainless steel GL-12H10-SJ
	1NO 自锁钮 Maintained	凸钮/焊接脚 High button/Welding	铜镀铬 Copper chromium plating GL-12H10T-NJ 不锈钢 Stainless steel GL-12H10T-SJ
安装孔径 12mm Mounting aperture	(24V红色 R) 1NO 自复钮 Momentary	平钮/焊接脚(环形带灯) Flat button/Welding (Annular belt lamp)	铜镀铬 Copper chromium plating GL-12F10E/R23-NJ 不锈钢 Stainless steel GL-12F10E/R23-SJ
	(24V红色 R) 1NO 自锁钮 Maintained	平钮/焊接脚(环形带灯) Flat button/Welding (Annular belt lamp)	铜镀铬 Copper chromium plating GL-12F10TE/R23-NJ 不锈钢 Stainless steel GL-12F10TE/R23-SJ
安装孔径 12mm Mounting aperture	(24V红色 R) 1NO 自复钮 Momentary	凸钮/焊接脚(单点带灯) High button/Welding (Single point belt lamp)	铜镀铬 Copper chromium plating GL-12H10D/R23-NJ 不锈钢 Stainless steel GL-12H10D/R23-SJ
	(24V红色 R) 1NO 自锁钮 Maintained	凸钮/焊接脚(单点带灯) High button/Welding (Single point belt lamp)	铜镀铬 Copper chromium plating GL-12H10TD/R23-NJ 不锈钢 Stainless steel GL-12H10TD/R23-SJ
安装孔径 12mm Mounting aperture	(24V红色 R) 1NO 自复钮 Momentary	凸钮/焊接脚(环形带灯) High button/Welding (Annular belt lamp)	铜镀铬 Copper chromium plating GL-12H10E/R23-NJ 不锈钢 Stainless steel GL-12H10E/R23-SJ
	(24V红色 R) 1NO 自锁钮 Maintained	凸钮/焊接脚(环形带灯) High button/Welding (Annular belt lamp)	铜镀铬 Copper chromium plating GL-12H10TE/R23-NJ 不锈钢 Stainless steel GL-12H10TE/R23-SJ

产品样式 Product style	描述 Description	外壳材料 Shell material	型号 Model
安装孔径 □16mm Mounting aperture	1NO 自复钮 Momentary 球形/接线柱 Spherical/Terminal	铜镀铬Copper chromium plating 不锈钢 Stainless steel	GL-16BA10-N GL-16BA10-S
	1NO 自复钮 Momentary 球形/焊接脚 Spherical/Weldingl	铜镀铬Copper chromium plating 不锈钢 Stainless steel	GL-16BA10-NJ GL-16BA10-SJ
安装孔径 □16mm Mounting aperture	1NO 自复钮 Momentary 平钮/接线柱 Flat button/Terminal	铜镀铬Copper chromium plating 不锈钢 Stainless steel	GL-16FA10-N GL-16FA10-S
	1NO 自复钮 Momentary 平钮/焊接脚 Flat button/Weldingl	铜镀铬Copper chromium plating 不锈钢 Stainless steel	GL-16FA10-NJ GL-16FA10-SJ
安装孔径 □16mm Mounting aperture	1NO 自复钮 Momentary 凸钮/接线柱 High button/Terminal	铜镀铬Copper chromium plating 不锈钢 Stainless steel	GL-16HA10-N GL-16HA10-S
	1NO 自复钮 Momentary 凸钮/焊接脚 High button/Weldingl	铜镀铬Copper chromium plating 不锈钢 Stainless steel	GL-16HA10-NJ GL-16HA10-SJ
安装孔径 □16mm Mounting aperture	(24V红色 R) 1NO 自复钮 Momentary 平钮/焊接脚(环形带灯) Flat button/Weldingl (Annular belt lamp)	铜镀铬Copper chromium plating 不锈钢 Stainless steel	GL-16FA10E/R23-NJ GL-16FA10E/R23-SJ
	(24V红色 R) 1NO 自复钮 Momentary 凸钮/焊接脚(环形带灯) High button/Weldingl (Annular belt lamp)	铜镀铬Copper chromium plating 不锈钢 Stainless steel	GL-16HA10E/R23-NJ GL-16HA10E/R23-SJ
安装孔径 □16mm Mounting aperture	(24V红色 R) 1NO 自复钮 Momentary 平钮/焊接脚(电源指示) Flat button/Weldingl (Power indication)	铜镀铬Copper chromium plating 不锈钢 Stainless steel	GL-16FA10S/R23-NJ GL-16FA10S/R23-SJ
	(24V红色 R) 1NO 自复钮 Momentary 凸钮/焊接脚(电源指示) High button/Weldingl (Power indication)	铜镀铬Copper chromium plating 不锈钢 Stainless steel	GL-16HA10S/R23-NJ GL-16HA10S/R23-SJ
安装孔径 □16mm Mounting aperture	平钮(自复钮)/焊接脚 Flat button(Momentary)/Weldingl	1NO+1NC 铜镀铬Copper chromium plating 2NO+2NC 不锈钢 Stainless steel	GL-16F11-NJ GL-16F22-SJ
	平钮(自锁钮)/焊接脚 Flat button(Maintained)/Weldingl	1NO+1NC 铜镀铬Copper chromium plating 2NO+2NC 不锈钢 Stainless steel	GL-16F11T-NJ GL-16F22T-SJ
	凸钮(自复钮)/焊接脚 High button(Momentary)/Weldingl	1NO+1NC 铜镀铬Copper chromium plating 2NO+2NC 不锈钢 Stainless steel	GL-16H11-NJ GL-16H22-SJ
	凸钮(自锁钮)/焊接脚 High button(Maintained)/Weldingl	1NO+1NC 铜镀铬Copper chromium plating 2NO+2NC 不锈钢 Stainless steel	GL-16H11T-NJ GL-16H22T-SJ
安装孔径 □16mm Mounting aperture	(24V红色 R) 平钮 Weldingl (Annular belt lamp)	自复钮 Momentary 1NO+1NC 铜镀铬Copper chromium plating 2NO+2NC 不锈钢 Stainless steel	GL-16F11E/R23-NJ GL-16F22E/R23-SJ
	(24V红色 R) 凸钮 Weldingl (Annular belt lamp)	自锁钮 Maintained 1NO+1NC 铜镀铬Copper chromium plating 2NO+2NC 不锈钢 Stainless steel	GL-16F11TE/R23-NJ GL-16F22TE/R23-SJ
	(24V红色 R) 平钮 Weldingl (Annular belt lamp)	自复钮 Momentary 1NO+1NC 铜镀铬Copper chromium plating 2NO+2NC 不锈钢 Stainless steel	GL-16H11E/R23-NJ GL-16H22E/R23-SJ
	(24V红色 R) 凸钮 Weldingl (Annular belt lamp)	自锁钮 Maintained 1NO+1NC 铜镀铬Copper chromium plating 2NO+2NC 不锈钢 Stainless steel	GL-16H11TE/R23-NJ GL-16H22TE/R23-SJ

产品样式 Product style	描述 Description	外壳材料 Shell material	型号 Model
安装孔径 □16mm Mounting aperture	(24V红色 R) 平钮 Weldingl (Power indication)	自复钮 Momentary 1NO+1NC 铜镀铬Copper chromium plating 2NO+2NC 不锈钢 Stainless steel	GL-16F11S/R23-NJ GL-16F11S/R23-SJ
	(24V红色 R) 凸钮 Weldingl (Power indication)	自锁钮 Maintained 1NO+1NC 铜镀铬Copper chromium plating 2NO+2NC 不锈钢 Stainless steel	GL-16F11TS/R23-NJ GL-16F11TS/R23-SJ
	(24V红色 R) 平钮 Weldingl (Power indication)	自复钮 Momentary 1NO+1NC 铜镀铬Copper chromium plating 2NO+2NC 不锈钢 Stainless steel	GL-16H11S/R23-NJ GL-16H11S/R23-SJ
	(24V红色 R) 凸钮 Weldingl (Power indication)	自锁钮 Maintained 1NO+1NC 铜镀铬Copper chromium plating 2NO+2NC 不锈钢 Stainless steel	GL-16H11TS/R23-NJ GL-16H11TS/R23-SJ



产品样式 Product style	描述 Description	外壳材料 Shell material	型号 Model
Mounting aperture □19mm	1NO 自复钮 Momentary 球形钮/接线柱 Spherical button/Terminal	铜镀铬Copper chromium plating 不锈钢 Stainless steel	GL-19BA10-N GL-19BA10-S
	1NO 自复钮 Momentary 球形钮/焊接脚 Spherical button/Weldingl	铜镀铬Copper chromium plating 不锈钢 Stainless steel	GL-19BA10-NJ GL-19BA10-SJ
Mounting aperture □19mm	1NO 自复钮 Momentary 平钮/接线柱 Flat button/Terminal	铜镀铬Copper chromium plating 不锈钢 Stainless steel	GL-19FA10-N GL-19FA10-S
	1NO 自复钮 Momentary 平钮/焊接脚 Flat button/Weldingl	铜镀铬Copper chromium plating 不锈钢 Stainless steel	GL-19FA10-NJ GL-19FA10-SJ
Mounting aperture □19mm	1NO 自复钮 Momentary 凸钮/接线柱 High button/Terminal	铜镀铬Copper chromium plating 不锈钢 Stainless steel	GL-19HA10-N GL-19HA10-S
	1NO 自复钮 Momentary 凸钮/焊接脚 High button/Weldingl	铜镀铬Copper chromium plating 不锈钢 Stainless steel	GL-19HA10-NJ GL-19HA10-SJ
Mounting aperture □19mm	(24V红色 R) 1NO 自复钮 Momentary 平钮/接线柱(环形带灯) Flat button/Terminal (Annular belt lamp)	铜镀铬Copper chromium plating 不锈钢 Stainless steel	GL-19FA10E/R23-N GL-19FA10E/R23-S
	(24V红色 R) 1NO 自复钮 Momentary 平钮/焊接脚(环形带灯) Flat button/Weldingl (Annular belt lamp)	铜镀铬Copper chromium plating 不锈钢 Stainless steel	GL-19FA10E/R23-NJ GL-19FA10E/R23-SJ
安装孔径 □19mm Mounting aperture	平钮/焊接脚 Flat button/Weldingl	自复钮 Momentary 1NO+1NC 铜镀铬Copper chromium plating 2NO+2NC 不锈钢 Stainless steel	GL-19F11-NJ GL-19F22-SJ
	平钮/焊接脚 Flat button/Weldingl	自锁钮 Maintained 1NO+1NC 铜镀铬Copper chromium plating 2NO+2NC 不锈钢 Stainless steel	GL-19F11T-NJ GL-19F22T-SJ
	凸钮/焊接脚 High button/Weldingl	自复钮 Momentary 1NO+1NC 铜镀铬Copper chromium plating 2NO+2NC 不锈钢 Stainless steel	GL-19H11-NJ GL-19H22-SJ
	凸钮/焊接脚 High button/Weldingl	自锁钮 Maintained 1NO+1NC 铜镀铬Copper chromium plating 2NO+2NC 不锈钢 Stainless steel	GL-19H11T-NJ GL-19H22T-SJ

金属按钮系列
metal push button series

金属按钮系列
metal push button series

产品样式 Product style	描述 Description	外壳材料 Shell material	型号 Model	
安装孔径 □19mm Mounting aperture	(24V红色 R) 平钮 焊接脚(环形带灯) Flat button Weldingl (Annular belt lamp)	自复钮 Momentary	1N0+1NC 铜镀铬Copper chromium plating GL-19F11E/R23-NJ 2N0+2NC 不锈钢 Stainless steel GL-19F22E/R23-SJ	
		自锁钮 Maintained	1N0+1NC 铜镀铬Copper chromium plating GL-19F11TE/R23-NJ 2N0+2NC 不锈钢 Stainless steel GL-19F22TE/R23-SJ	
	(24V红色 R) 凸钮 焊接脚(环形带灯) High button Weldingl (Annular belt lamp)	自复钮 Momentary	1N0+1NC 铜镀铬Copper chromium plating GL-19H11E/R23-NJ 2N0+2NC 不锈钢 Stainless steel GL-19H22E/R23-SJ	
		自锁钮 Maintained	1N0+1NC 铜镀铬Copper chromium plating GL-19H11TE/R23-NJ 2N0+2NC 不锈钢 Stainless steel GL-19H22TE/R23-SJ	
	安装孔径 □19mm Mounting aperture	(24V红色 R) 平钮 焊接脚(电源指示) Flat button Weldingl (Power indication)	自复钮 Momentary	1N0+1NC 铜镀铬Copper chromium plating GL-19F11S/R23-NJ 2N0+2NC 不锈钢 Stainless steel GL-19F22S/R23-SJ
			自锁钮 Maintained	1N0+1NC 铜镀铬Copper chromium plating GL-19F11TS/R23-NJ 2N0+2NC 不锈钢 Stainless steel GL-19F22TS/R23-SJ
(24V红色 R) 凸钮 焊接脚(电源指示) High button Weldingl (Power indication)		自复钮 Momentary	1N0+1NC 铜镀铬Copper chromium plating GL-19H11S/R23-NJ 2N0+2NC 不锈钢 Stainless steel GL-19H22S/R23-SJ	
		自锁钮 Maintained	1N0+1NC 铜镀铬Copper chromium plating GL-19H11TS/R23-NJ 2N0+2NC 不锈钢 Stainless steel GL-19H22TS/R23-SJ	
Mounting aperture □19mm	焊接脚 Weldingl	二档旋钮 2-Position Selector button	1N0+1NC 铜镀铬Copper chromium plating GL-19X11-NJ 2N0+2NC 不锈钢 Stainless steel GL-19X22-SJ	
		三档旋钮 3-Position Selector button	2N0+2NC 铜镀铬Copper chromium plating GL-19XS22-NJ 2N0+2NC 不锈钢 Stainless steel GL-19XS22-SJ	
		二档旋钮 2-Position Selector button	1N0+1NC 铜镀铬Copper chromium plating GL-19X11/R23-NJ 2N0+2NC 不锈钢 Stainless steel GL-19X22/R23-SJ	
Mounting aperture □19mm	焊接脚 Weldingl (24V红色 R)	三档旋钮 3-Position Selector button	2N0+2NC 铜镀铬Copper chromium plating GL-19XS22/R23-NJ 2N0+2NC 不锈钢 Stainless steel GL-19XS22/R23-SJ	
		二档旋钮 2-Position Selector button	1N0+1NC 铜镀铬Copper chromium plating GL-19Y11-NJ 2N0+2NC 不锈钢 Stainless steel GL-19Y11-SJ	
		三档旋钮 3-Position keylock selector	2N0+2NC 铜镀铬Copper chromium plating GL-19YS22-NJ 2N0+2NC 不锈钢 Stainless steel GL-19YS22-SJ	
Mounting aperture □19mm	蘑菇钮 Mushroom push button 焊接脚 Weldingl	1N0+1NC 铜镀铬Copper chromium plating GL-19M11/R-NJ 2N0+2NC 不锈钢 Stainless steel GL-19M22/R-NJ		
		1N0+1NC 铜镀铬Copper chromium plating GL-19M11/R-SJ 2N0+2NC 不锈钢 Stainless steel GL-19M22/R-SJ		
		1N0+1NC 铜镀铬Copper chromium plating GL-19Z11-AJ 2N0+2NC 铜镀铬Copper chromium plating GL-19Z22-AJ		
Mounting aperture □19mm	急停 Emergency stop button 焊接脚 Weldingl	1N0+1NC 铜镀铬Copper chromium plating GL-19Z11-AJ 2N0+2NC 铜镀铬Copper chromium plating GL-19Z22-AJ		
		1N0+1NC 铜镀铬Copper chromium plating GL-19ZC11-AJ 2N0+2NC 铜镀铬Copper chromium plating GL-19ZC22-AJ		



GL-19 壳体可电镀彩色
The shell can be plated with color

产品样式 Product style	描述 Description	外壳材料 Shell material	型号 Model
安装孔径 □22mm Mounting aperture	平钮/接线柱 Flat button/ Terminal	自复钮 Momentary	1N0 铜镀铬Copper chromium plating GL-22FA10-N 1N0 不锈钢 Stainless steel GL-22FA10-S
		自锁钮 Momentary	1N0 铜镀铬Copper chromium plating GL-22HA10-N 1N0 不锈钢 Stainless steel GL-22HA10-S
Mounting aperture □22mm	(24V红色 R) 平钮/接线柱(环形带灯) Flat button/ Terminal (Annular belt lamp)	自复钮 Momentary	1N0 铜镀铬Copper chromium plating GL-22FA10E/R23-N 1N0 不锈钢 Stainless steel GL-22FA10E/R23-S
		自锁钮 Maintained	1N0 铜镀铬Copper chromium plating GL-22FA10TE/R23-N 1N0 不锈钢 Stainless steel GL-22FA10TE/R23-S
Mounting aperture □22mm	平钮/焊接脚 Flat button/ Weldingl	自复钮 Momentary	1N0+1NC 铜镀铬Copper chromium plating GL-22F11-NJ 1N0+1NC 不锈钢 Stainless steel GL-22F11-SJ
		自锁钮 Maintained	1N0+1NC 铜镀铬Copper chromium plating GL-22F11T-NJ 1N0+1NC 不锈钢 Stainless steel GL-22F11T-SJ
Mounting aperture □22mm	(24V红色 R) 平钮 Flat button 焊接脚(环形带灯) Weldingl (Annular belt lamp)	自复钮 Momentary	1N0+1NC 铜镀铬Copper chromium plating GL-22F11E/R23-NJ 1N0+1NC 不锈钢 Stainless steel GL-22F11E/R23-SJ
		自锁钮 Maintained	1N0+1NC 铜镀铬Copper chromium plating GL-22F11TE/R23-NJ 1N0+1NC 不锈钢 Stainless steel GL-22F11TE/R23-SJ
Mounting aperture □22mm	(24V红色 R) 平钮 Flat button 焊接脚(电源指示) Weldingl (Power indication)	自复钮 Momentary	1N0+1NC 铜镀铬Copper chromium plating GL-22F11S/R23-NJ 1N0+1NC 不锈钢 Stainless steel GL-22F11S/R23-SJ
		自锁钮 Maintained	1N0+1NC 铜镀铬Copper chromium plating GL-22F11TS/R23-NJ 1N0+1NC 不锈钢 Stainless steel GL-22F11TS/R23-SJ
Mounting aperture □22mm	焊接脚 Weldingl	二档旋钮 2-Position Selector button	1N0+1NC 铜镀铬Copper chromium plating GL-22X11-NJ 2N0+2NC 不锈钢 Stainless steel GL-22X22-SJ
		三档旋钮 3-Position Selector button	2N0+2NC 铜镀铬Copper chromium plating GL-22XS22-NJ 2N0+2NC 不锈钢 Stainless steel GL-22XS22-SJ
		二档旋钮 2-Position Selector button	1N0+1NC 铜镀铬Copper chromium plating GL-22X11/R23-NJ 2N0+2NC 不锈钢 Stainless steel GL-22X22/R23-SJ
Mounting aperture □22mm	焊接脚 Weldingl (24V红色 R)	三档旋钮 3-Position Selector button	2N0+2NC 铜镀铬Copper chromium plating GL-22XS22/R23-NJ 2N0+2NC 不锈钢 Stainless steel GL-22XS22/R23-SJ
		二档旋钮 2-Position Selector button	1N0+1NC 铜镀铬Copper chromium plating GL-22BE11-SJ 2N0+2NC 不锈钢 Stainless steel GL-22BE22-SJ
		三档旋钮 3-Position Selector button	1N0+1NC 不锈钢 Stainless steel GL-22BE11T-SJ 2N0+2NC 不锈钢 Stainless steel GL-22BE22T-SJ
Mounting aperture □22mm	圆外套球形钮 Spherical (Round coat)	自复钮 Momentary	1N0+1NC 铜镀铬Copper chromium plating GL-22BE11-SJ 2N0+2NC 不锈钢 Stainless steel GL-22BE22-SJ
		自锁钮 Maintained	1N0+1NC 不锈钢 Stainless steel GL-22BE11T-SJ 2N0+2NC 不锈钢 Stainless steel GL-22BE22T-SJ
Mounting aperture □22mm	焊接脚 Weldingl 圆外套平钮 Flat button(Round coat)	自复钮 Momentary	1N0+1NC 不锈钢 Stainless steel GL-22FE11-SJ 2N0+2NC 不锈钢 Stainless steel GL-22FE22-SJ
		自锁钮 Maintained	1N0+1NC 不锈钢 Stainless steel GL-22FE11T-SJ 2N0+2NC 不锈钢 Stainless steel GL-22FE22T-SJ
Mounting aperture □22mm	焊接脚 Weldingl 圆外套凸钮 High button(Round coat)	自复钮 Momentary	1N0+1NC 不锈钢 Stainless steel GL-22HE11-SJ 2N0+2NC 不锈钢 Stainless steel GL-22HE22-SJ
		自锁钮 Maintained	1N0+1NC 不锈钢 Stainless steel GL-22HE11T-SJ 2N0+2NC 不锈钢 Stainless steel GL-22HE22T-SJ
Mounting aperture □22mm	焊接脚 Weldingl 24V 红色 R 环形带灯 Annular belt lamp 圆外套平钮 Flat button(Round coat)	自复钮 Momentary	1N0+1NC 不锈钢 Stainless steel GL-22FE11E/R23-SJ 2N0+2NC 不锈钢 Stainless steel GL-22FE22E/R23-SJ
		自锁钮 Maintained	1N0+1NC 不锈钢 Stainless steel GL-22FE11TE/R23-SJ 2N0+2NC 不锈钢 Stainless steel GL-22FE22TE/R23-SJ

产品样式 Product style	描述 Description	外壳材料 Shell material	型号 Model
Mounting aperture □22mm 焊接脚 Weldingl 圆外套平钮 Flat button(Round coat)	自复钮 Momentary 绿色 G 1N0+1NC 24V 绿色 G 1N0+1NC	塑料 Plastic	GL-22FE11/G-PJ GL-22FE11/G23-PJ
	自锁钮 Maintained 红色钮 R 2N0+2NC 24V 红色 R 1N0+1NC	塑料 Plastic	GL-22FE22T/R-PJ GL-22FE11T/R23-PJ
电源指示 Power indication 焊接脚 Weldingl 圆外套平钮 Flat button(Round coat)	自复钮 Momentary 绿色 G 1N0+1NC 24V 绿色 G 1N0+1NC	塑料 Plastic	GL-22FE11S/G-PJ GL-22FE11S/G23-PJ
	自锁钮 Maintained 红色钮 R 1N0+1NC 24V 红色 R 1N0+1NC	塑料 Plastic	GL-22FE11TS/R-PJ GL-22FE11TS/R23-PJ
Mounting aperture □22mm 焊接脚 Weldingl 方外套球形钮 Spherical (Square coat)	自复钮 Momentary 1N0+1NC 2N0+2NC	不锈钢 Stainless steel	GL-22BF11-SJ GL-22BF22-SJ
	自锁钮 Maintained 1N0+1NC 2N0+2NC	不锈钢 Stainless steel	GL-22BF11T-SJ GL-22BF22T-SJ
Mounting aperture □22mm 焊接脚 Weldingl 方外套平钮 Flat button(Square coat)	自复钮 Momentary 1N0+1NC 2N0+2NC	不锈钢 Stainless steel	GL-22FF11-SJ GL-22FF22-SJ
	自锁钮 Maintained 1N0+1NC 2N0+2NC	不锈钢 Stainless steel	GL-22FF11T-SJ GL-22FF22T-SJ
Mounting aperture □22mm 焊接脚 Weldingl 方外套凸钮 High button(Square coat)	自复钮 Momentary 1N0+1NC 2N0+2NC	不锈钢 Stainless steel	GL-22HF11-SJ GL-22HF22-SJ
	自锁钮 Maintained 1N0+1NC 2N0+2NC	不锈钢 Stainless steel	GL-22HF11T-SJ GL-22HF22T-SJ
Mounting aperture □22mm 焊接脚 Weldingl 24V 红色 R 环形带灯 Annular belt lamp 方外套平钮 Flat button(Square coat)	自复钮 Momentary 1N0+1NC 2N0+2NC	不锈钢 Stainless steel	GL-22FF11E/R23-SJ GL-22FF22E/R23-SJ
	自锁钮 Maintained 1N0+1NC 2N0+2NC	不锈钢 Stainless steel	GL-22FF11TE/R23-SJ GL-22FF22TE/R23-SJ
Mounting aperture □25mm 平钮/焊接脚 Flat button/Weldingl	自复钮 Momentary 1N0+1NC 2N0+2NC	不锈钢 Stainless steel	GL-25F11-SJ GL-25F22-SJ
	自锁钮 Maintained 1N0+1NC 2N0+2NC	不锈钢 Stainless steel	GL-25F11T-SJ GL-25F22T-SJ
Mounting aperture □25mm 凸钮/接线柱 High button/Terminal	自复钮 Momentary 1N0+1NC 2N0+2NC	不锈钢 Stainless steel	GL-25H11-SJ GL-25H22-SJ
	自锁钮 Maintained 1N0+1NC 2N0+2NC	不锈钢 Stainless steel	GL-25H11T-SJ GL-25H22T-SJ
Mounting aperture □25mm (24V红色 R) 平钮 Flat button 焊接脚(单点带灯) Weldingl (Single point)	自复钮 Momentary 1N0+1NC 2N0+2NC	不锈钢 Stainless steel	GL-25F11D/R23-SJ GL-25F22D/R23-SJ
	自锁钮 Maintained 1N0+1NC 2N0+2NC	不锈钢 Stainless steel	GL-25F11TD/R23-SJ GL-25F22TD/R23-SJ
Mounting aperture □25mm (24V红色 R) 平钮 Flat button 焊接脚(环形带灯) Weldingl (Annular belt lamp)	自复钮 Momentary 1N0+1NC 2N0+2NC	不锈钢 Stainless steel	GL-25F11E-SJ GL-25F22E-SJ
	自锁钮 Maintained 1N0+1NC 2N0+2NC	不锈钢 Stainless steel	GL-25F11TE-SJ GL-25F22TE-SJ
Mounting aperture □25mm (24V红色 R) 平钮 Flat button 焊接脚(电源指示) Weldingl (Power indication)	自复钮 Momentary 1N0+1NC 2N0+2NC	不锈钢 Stainless steel	GL-25F11S/R23-SJ GL-25F22S/R23-SJ
	自锁钮 Maintained 1N0+1NC 2N0+2NC	不锈钢 Stainless steel	GL-25F11TS/R23-SJ GL-25F22TS/R23-SJ

产品样式 Product style	描述 Description	外壳材料 Shell material	型号 Model
Mounting aperture □30mm 平钮/焊接脚 Flat button/Weldingl	自复钮 Momentary 1N0+1NC 2N0+2NC	不锈钢 Stainless steel	GL-30F11-SJ GL-30F22-SJ
	自锁钮 Maintained 1N0+1NC 2N0+2NC	不锈钢 Stainless steel	GL-30F11T-SJ GL-30F22T-SJ
Mounting aperture □30mm 凸钮/接线柱 High button/Terminal	自复钮 Momentary 1N0+1NC 2N0+2NC	不锈钢 Stainless steel	GL-30H11-SJ GL-30H22-SJ
	自锁钮 Maintained 1N0+1NC 2N0+2NC	不锈钢 Stainless steel	GL-30H11T-SJ GL-30H22T-SJ
Mounting aperture □30mm (24V红色 R) 平钮 Flat button 焊接脚(单点带灯) Weldingl (Single point)	自复钮 Momentary 1N0+1NC 2N0+2NC	不锈钢 Stainless steel	GL-30F11D/R23-SJ GL-30F22D/R23-SJ
	自锁钮 Maintained 1N0+1NC 2N0+2NC	不锈钢 Stainless steel	GL-30F11TD/R23-SJ GL-30F22TD/R23-SJ
Mounting aperture □30mm (24V红色 R) 平钮 Flat button 焊接脚(环形带灯) Weldingl (Annular belt lamp)	自复钮 Momentary 1N0+1NC 2N0+2NC	不锈钢 Stainless steel	GL-30F11E/R23-SJ GL-30F22E/R23-SJ
	自锁钮 Maintained 1N0+1NC 2N0+2NC	不锈钢 Stainless steel	GL-30F11TE/R23-SJ GL-30F22TE/R23-SJ
Mounting aperture □30mm (24V红色 R) 平钮 Flat button 焊接脚(电源指示) Weldingl (Power indication)	自复钮 Momentary 1N0+1NC 2N0+2NC	不锈钢 Stainless steel	GL-30F11S/R23-SJ GL-30F22S/R23-SJ
	自锁钮 Maintained 1N0+1NC 2N0+2NC	不锈钢 Stainless steel	GL-30F11TS/R23-SJ GL-30F22TS/R23-SJ
按钮插座 button socket	5根线 wireway	塑料 Plastic	GL-S16-5
按钮插座 button socket 适应安装尺寸: Suitable for installation size: □16、□19、□22mm大底座 Large base	8根线 wireway	塑料 Plastic	GL-S16-8
按钮插座 button socket 适应安装尺寸: Suitable for installation size: □22、□25、□30mm大底座 Large base	6根线 wireway	塑料 Plastic	GL-S22-6
按钮插座 Button socket 适应安装尺寸: Suitable for installation size: □22、□25、□30mm大底座 Large base	10根线 wireway	塑料 Plastic	GL-S25-10
按钮防护座 Button protection seat 适应安装尺寸: □19mm Suitable for installation size: □19mm		塑料 Plastic	GXB2-EC19
按钮防护片 Button shield 适应安装尺寸: □16mm Suitable for installation size: □16mm		塑料 Plastic	GXB2-ZB16FL
按钮防护片 Button shield 适应安装尺寸: □19mm Suitable for installation size: □19mm		塑料 Plastic	GXB2-ZB19FL
按钮防护片 Button shield 适应安装尺寸: □22mm Suitable for installation size: □22mm		塑料 Plastic	GXB2-ZB22FL

Explanation of Type Designation

Example:

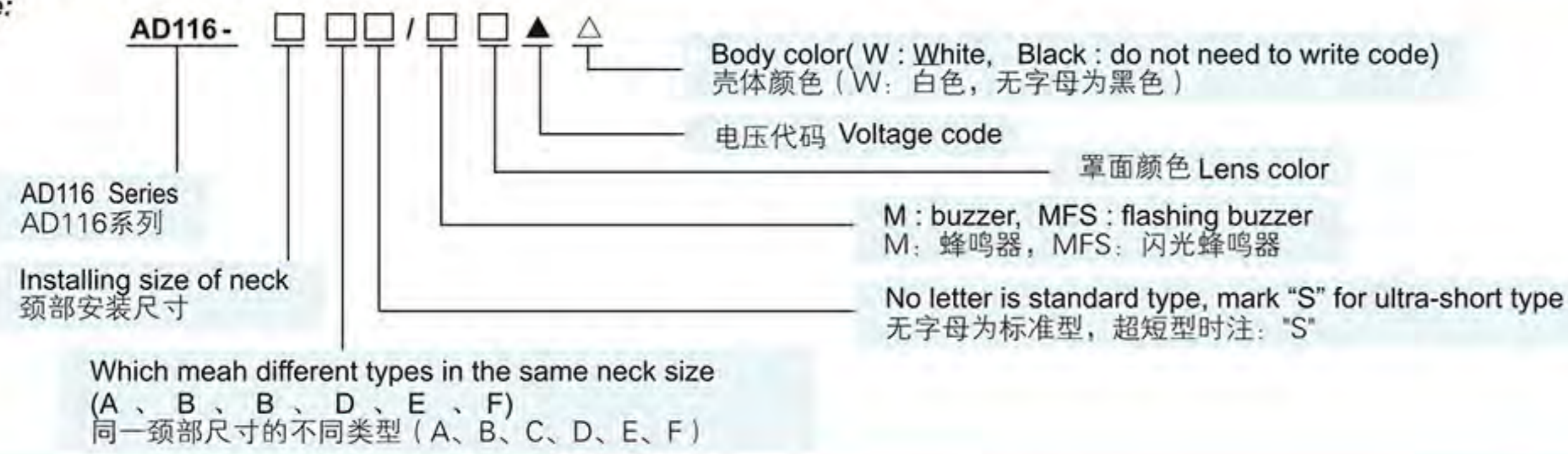

	φ22 LED电压指示灯 电压测试范围: AC-50~500V	红、绿、黄色 蓝、白色	AD116-22DSV/▲△ AD116-22DSV/W△
	φ22 LED电流指示灯 电流测试范围: 1A~100A	红、绿、黄色 蓝、白色	AD116-22DSA/▲△ AD116-22DSA/W△
	φ22 LED赫兹表 频率测试范围: 20Hz~450Hz 输入电压: 50V~500V	红、绿、黄色 蓝、白色	AD116-22DHZ/▲△ AD116-22DHZ/W△
	φ22 蜂鸣器 (拧开产品罩面可自行切换以下发声模式) 持续发声、间断发声、指示灯闪亮间断发声声响延时关闭	红、绿、黄	AD116-22DS/MFS/▲△

互感器参数:
变比: 2000:1
测量电流: 1~99.9A
输入电流: 100A 输出50mA
使用说明: 壳体后面两条引线为互感器专用连接线
请勿直接连接电源使用以免损毁产品

以上产品可定制直流产品(电压范围12V~135V)

描述 Description	电压 Voltage	尺寸 Contour	描述 Description	电压 Voltage	尺寸 Contour
指示灯 Pilot Light φ16	AC/DC 6V 12V 24V 36V 48V 110V 127V 220V 380V	AC 	蜂鸣器 Buzzer φ16	AC/DC 6V 12V 127V 24V 36V 220V 48V 110V 127V 220V 380V	AC
指示灯 Pilot Light φ16	AC/DC 6V 12V 24V 36V 48V 110V 127V 220V 380V	AC 	蜂鸣器 Ultra-short flashing buzzer φ16	AC/DC 6V 12V 127V 24V 36V 220V 48V 110V 127V 220V 380V	AC

描述 Description	电压 Voltage	尺寸 Contour	描述 Description	电压 Voltage	尺寸 Contour
指示灯 Pilot Light φ22	AC/DC 6V 12V 24V 36V 48V 110V 127V 220V 380V	AC 	指示灯 Pilot Light φ22	AC/DC 6V 12V 24V 36V 48V 110V 127V 220V 380V	AC
指示灯 Pilot Light φ22	AC/DC 6V 12V 24V 36V 48V 110V 127V 220V 380V	AC 	指示灯 Pilot Light φ22	AC/DC 6V 12V 24V 36V 48V 110V 127V 220V 380V	AC
指示灯 Pilot Light φ22	AC/DC 6V 12V 24V 36V 48V 110V 127V 220V 380V	AC 	指示灯 Pilot Light φ22	AC/DC 6V 12V 24V 36V 48V 110V 127V 220V 380V	AC
指示灯 Pilot Light φ22	AC/DC 6V 12V 24V 36V 48V 110V 127V 220V 380V	AC 	闪光指示灯 Flashing indicator lamp φ22	AC/DC 6V 12V 24V 36V 48V 110V 127V 220V 380V	AC
指示灯 Pilot Light φ22	AC/DC 6V 12V 24V 36V 48V 110V 127V 220V 380V	AC 	闪光指示灯 Flashing indicator lamp φ22	AC/DC 6V 12V 24V 36V 48V 110V 127V 220V 380V	AC

AD116 信号灯系列
AD116 signal lamp series

AD116 信号灯系列
AD116 signal lamp series

描述 Description	电压 Voltage	尺寸 Contour	描述 Description	电压 Voltage	尺寸 Contour
双色指示灯 Double-color Light $\phi 22$	AC/DC 6V 12V 24V 36V 48V 110V 127V 220V 380V	AC 	闪光蜂鸣器 Flashing buzzer $\phi 22$	AC/DC 6V 12V 24V 36V 48V 110V 127V 220V 380V	AC
AD116-22D/B ● 1 ● 2 ● 3 ● 4 ● 5 ● 6			AD116-22B/MFS ● ● ● ● ●		
指示灯 Pilot Light $\phi 22$	AC/DC 6V 12V 24V 36V 48V 110V 127V 220V 380V	AC 	蜂鸣器 Buzzer $\phi 22$	AC/DC 6V 12V 127V 24V 36V 220V 48V 110V 127V 220V 380V	AC
AD116-22W/D ● 1 ● 2 ● 3 ● 4 ● 5 ● 6			AD116-22DS/M ●		
蜂鸣器 Buzzer $\phi 22$	AC/DC 6V 12V 24V 36V 48V 110V 127V 220V 380V	AC 	闪光蜂鸣器 Flashing buzzer $\phi 22$	AC/DC 6V 12V 127V 24V 36V 220V 48V 110V 127V 220V 380V	AC
AD116-22BS/M ●			AD116-22DS/MFS ● ● ● ● ●		
闪光蜂鸣器 Flashing buzzer $\phi 22$	AC/DC 6V 12V 24V 36V 48V 110V 127V 220V 380V	AC 	蜂鸣器 Buzzer $\phi 22$	AC/DC 6V 12V 127V 24V 36V 220V 48V 110V 127V 220V 380V	AC
AD116-22BS/MFS ● ● ● ● ●			AD116-22D/M ●		
蜂鸣器 Buzzer $\phi 22$	AC/DC 6V 12V 24V 36V 48V 110V 127V 220V 380V	AC 	闪光蜂鸣器 Flashing buzzer $\phi 22$	AC/DC 6V 12V 127V 24V 36V 220V 48V 110V 127V 220V 380V	AC
AD116-22B/M ●			AD116-22D/MFS ● ● ● ● ●		

描述 Description	电压 Voltage	尺寸 Contour	描述 Description	电压 Voltage	尺寸 Contour
指示灯 Pilot Light $\phi 30$	AC/DC 6V 12V 24V 36V 48V 110V 127V 220V 380V	AC 	蜂鸣器 Buzzer $\phi 30$	AC/DC 6V 12V 127V 24V 36V 220V 48V 110V 127V 220V 380V	AC
AD116-30DS ● ● ● ● ●			AD116-30DS/MFS ● ● ● ● ●		
样式 Photo	型号 Type	电压 Voltage	尺寸 Contour	电路 Circuit	颜色 Color
	GQ/AD22-C6 ▲△	6V~220V			● ● ● ● ● ●
	安装孔径 (Mounting aperture): □6mm				
	GQ/AD22-C8 ▲△	6V~220V			● ● ● ● ● ●
	安装孔径 (Mounting aperture): □8mm				
	GQ/AD22-C10 ▲△	6V~220V			● ● ● ● ● ●
	安装孔径 (Mounting aperture): □10mm				
	GQ/AD22-C12 ▲△	6V~220V			● ● ● ● ● ●
	安装孔径 (Mounting aperture): □12mm				
	GQ/AD22-C14 ▲△	6V~220V			● ● ● ● ● ●
	安装孔径 (Mounting aperture): □14mm				
	GQ/AD22-C16 ▲△	6V~220V			● ● ● ● ● ●
	安装孔径 (Mounting aperture): □16mm				

AD116 信号灯系列
AD116 signal lamp series

AD116 信号灯系列
AD116 signal lamp series

标示灯型号说明 MODEL AND MEANING

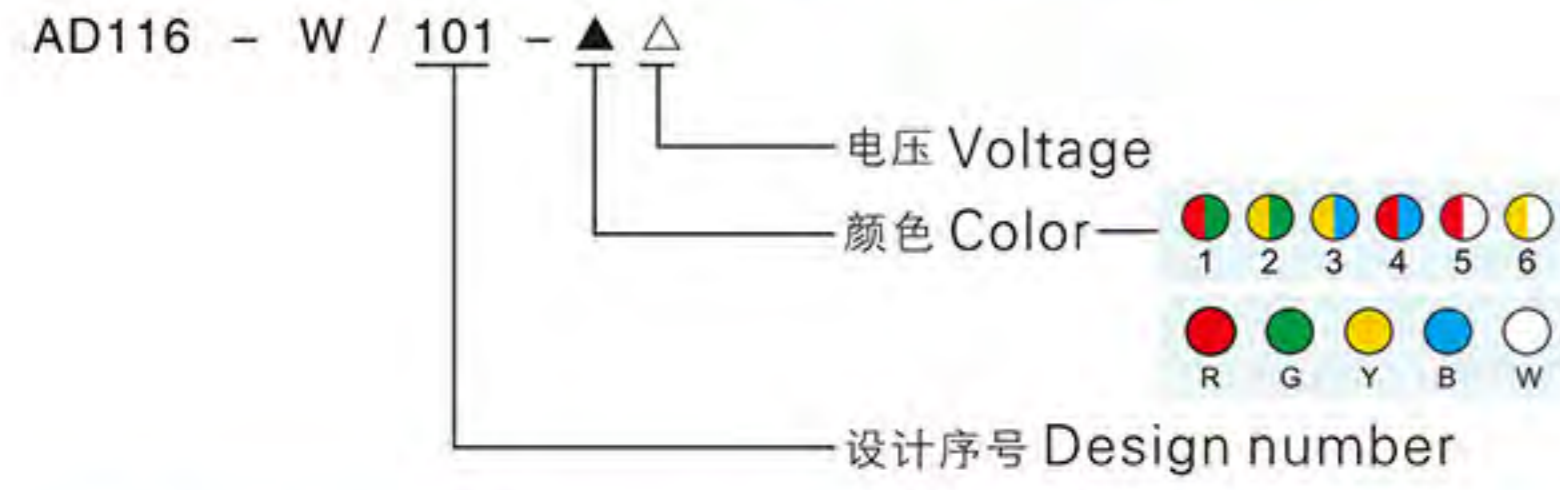

外形尺寸 External dimensions

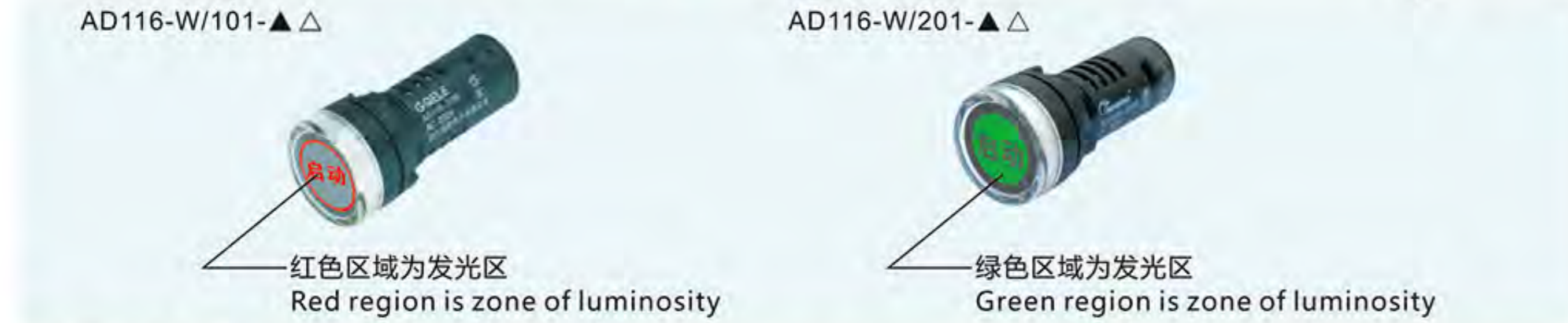
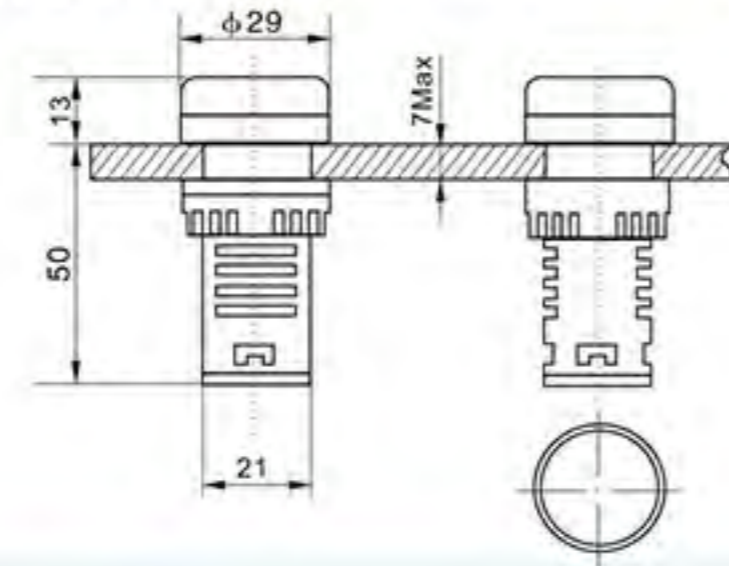

以下指示符号，供参考: The following indicator symbols for your information.

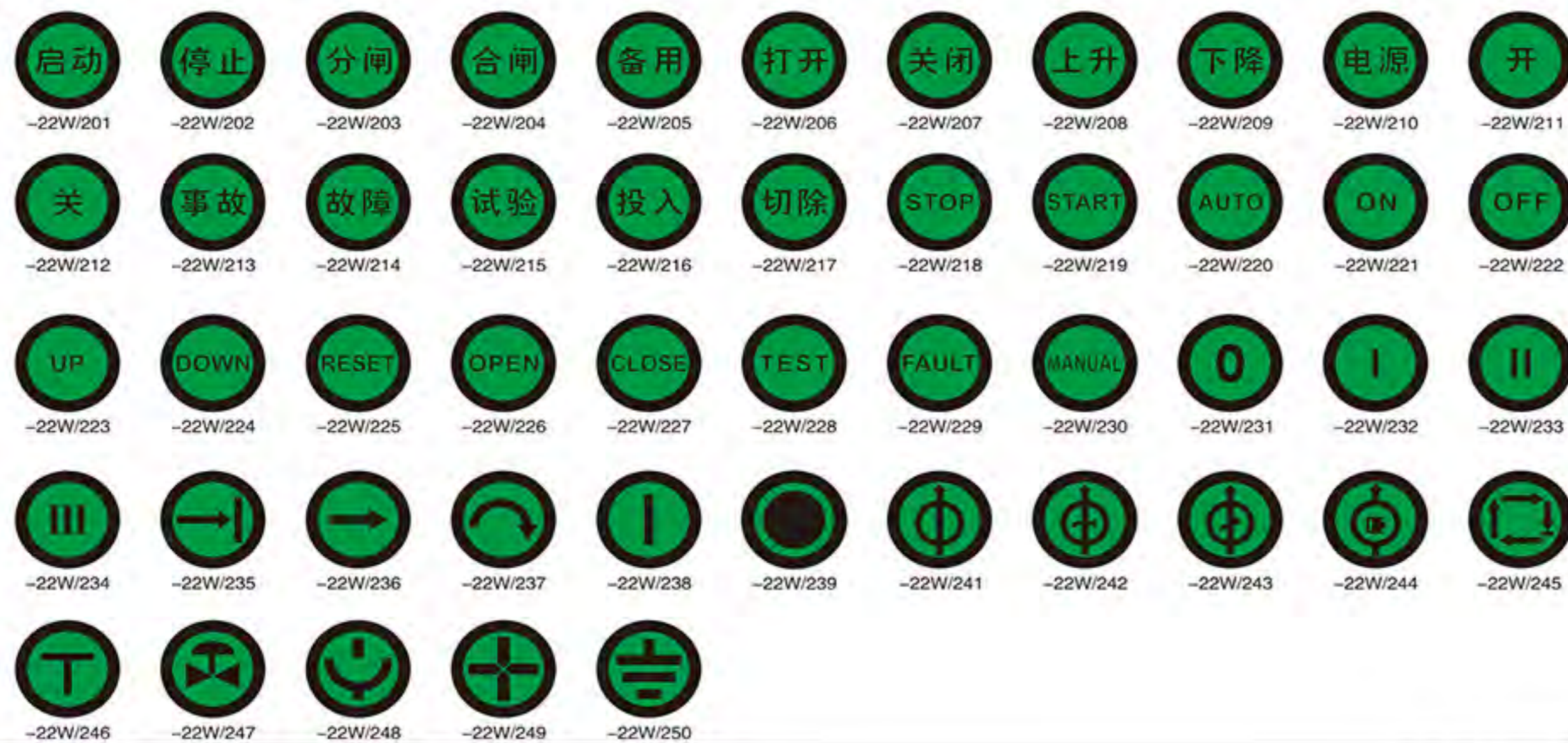

信号灯型号说明 Model & Explanation

光示牌系列 Symbol Light Model & Explanation

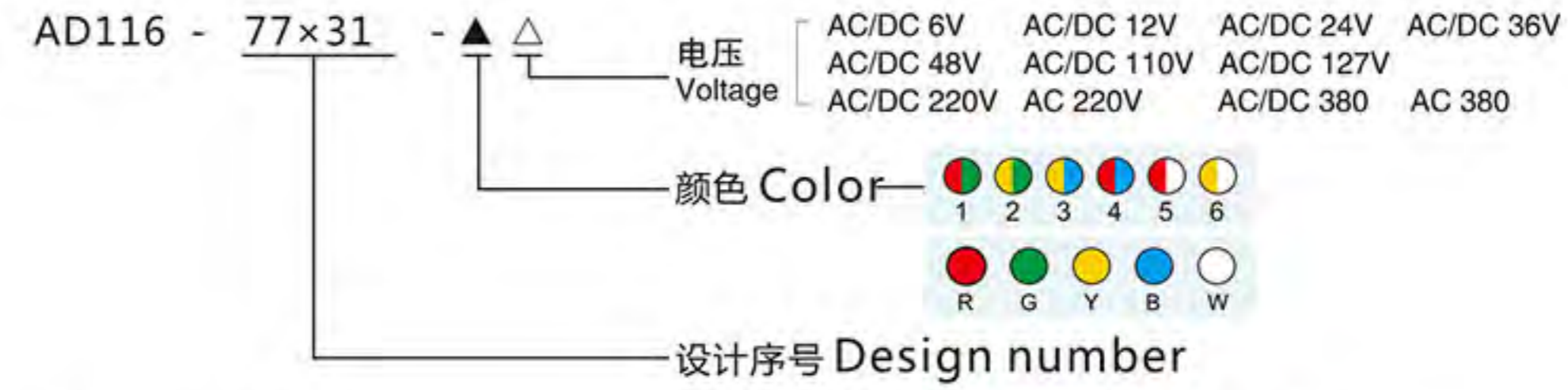





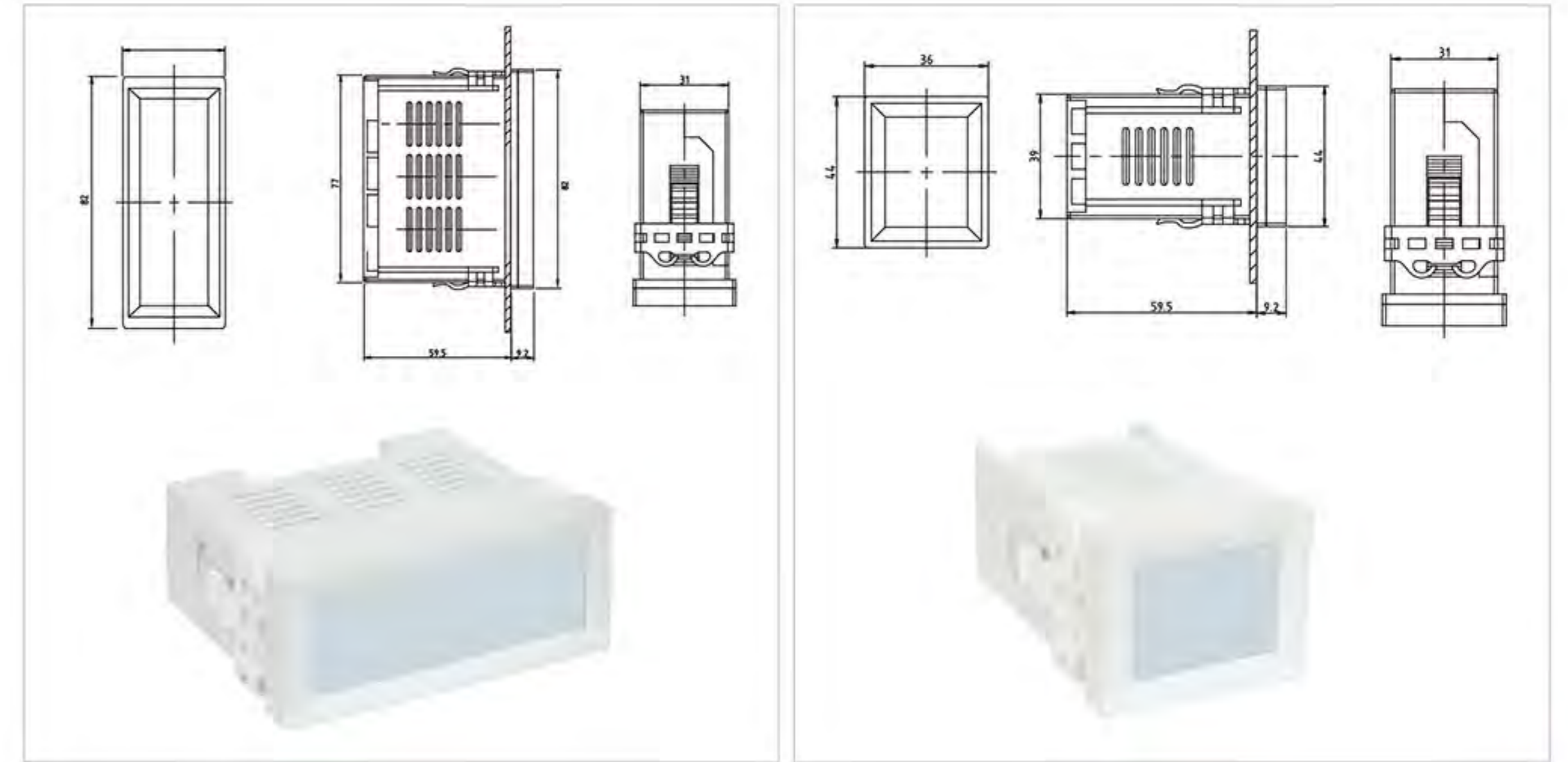





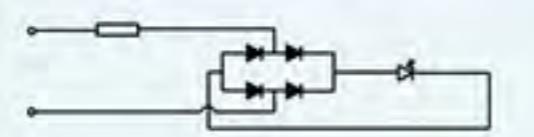
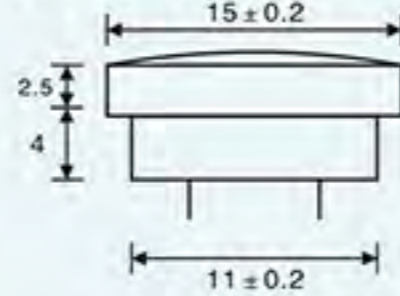
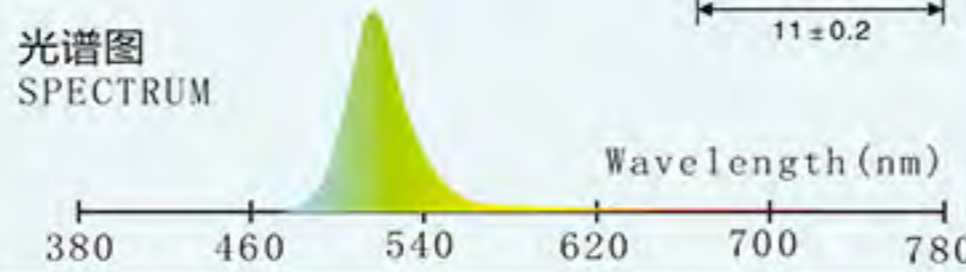

AD116-77×31

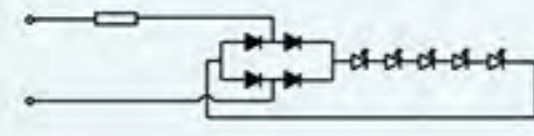
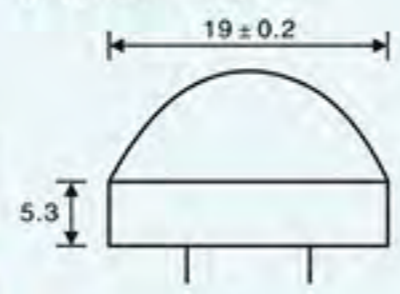
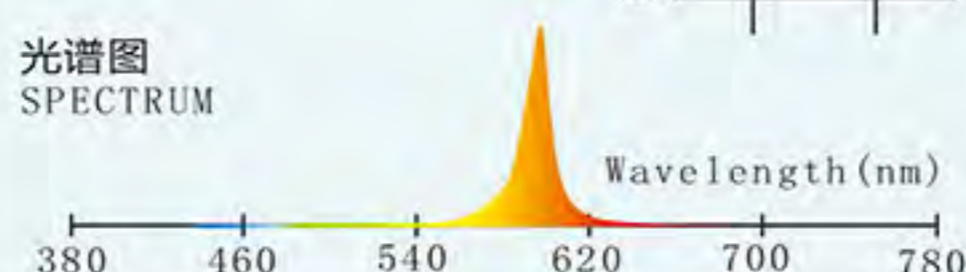

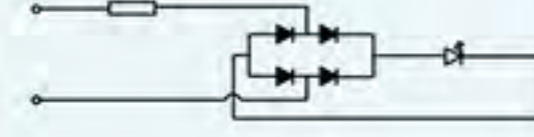
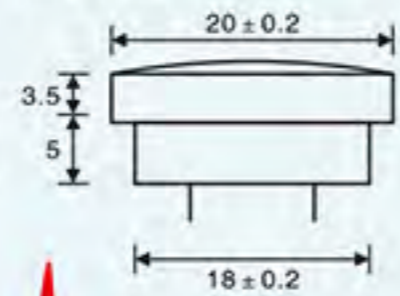
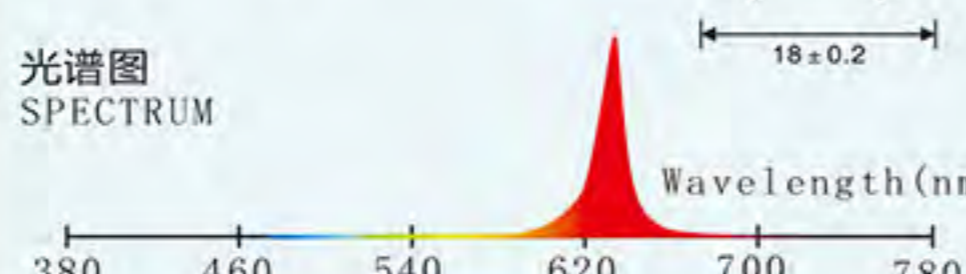

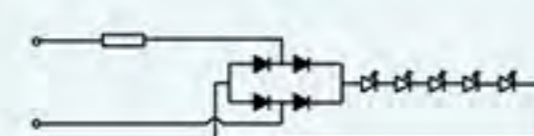
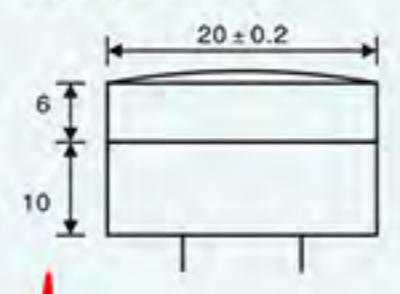
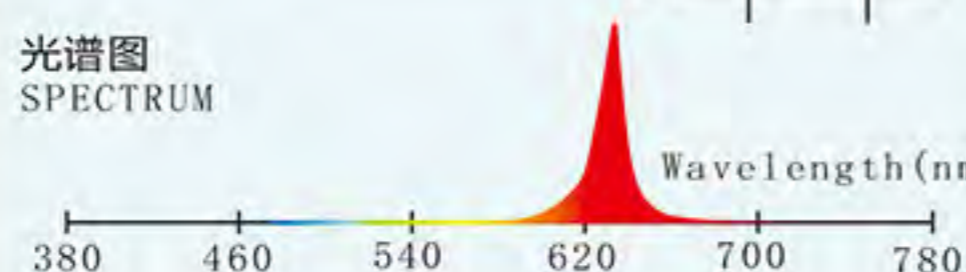

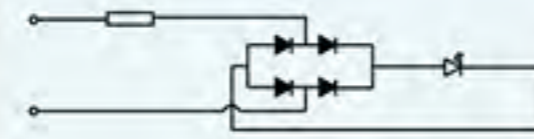
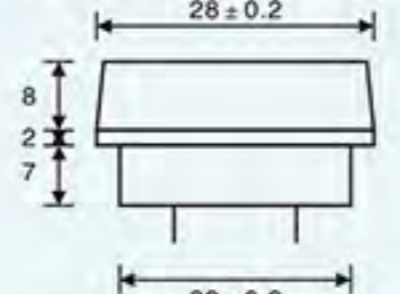
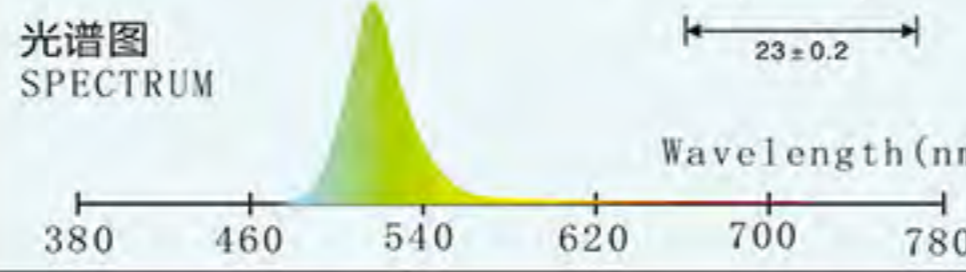
AD116-39×31

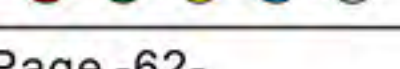
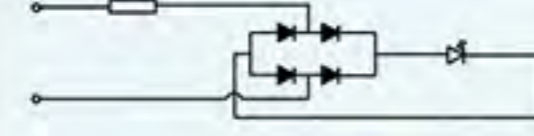
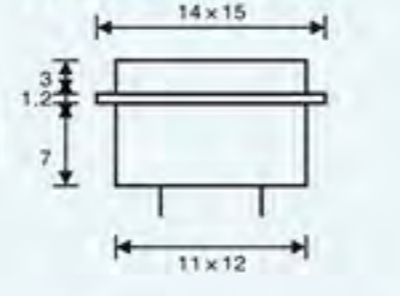
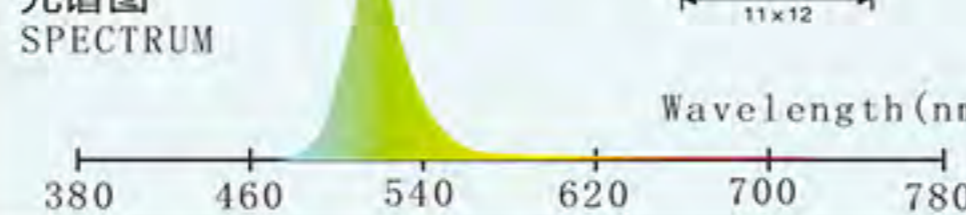

符号及印字标牌或标牌框印字 Legend plate text or legend frame printing

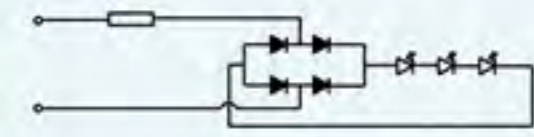
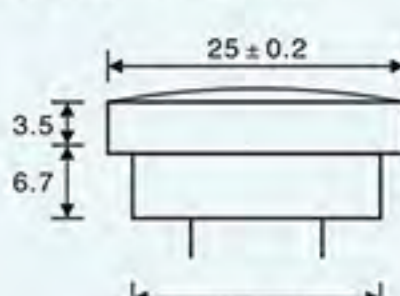
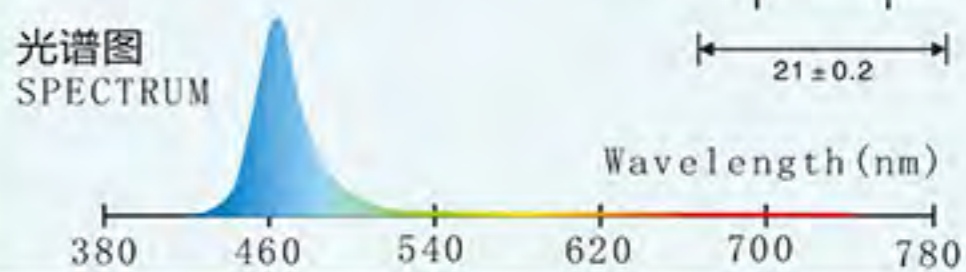

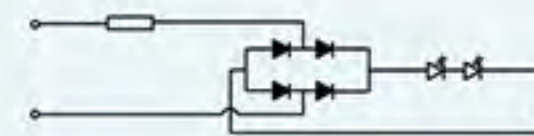
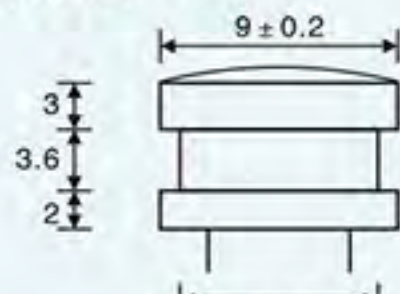
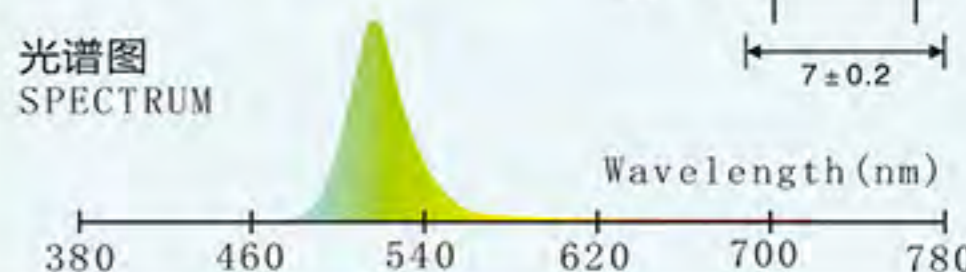
样式 (Photo)	灯头电压 (Head Voltage)	适配电压 (Suitable Assemble Voltage)	适合配置 (Set-up)	主要技术参数 (Main technical parameters)
 Φ15 	4.4V-6V	6.3V、12V	AD116-16 AD22-16B、16D、16E	电气原理图 Electric principle  尺寸图 Diagram  光谱图 SPECTRUM 
 Φ19 	4.4V-5.4V	6.3V	AD11-22 AD16-22A AD16-25A	电气原理图 Electric principle  尺寸图 Diagram  光谱图 SPECTRUM 
 Φ20 	4.4V-5.4V	6.3V、12V	AD116-22 AD22-22B 22D、22E	电气原理图 Electric principle  尺寸图 Diagram  光谱图 SPECTRUM 
 Φ20 	4.4V-6V	6.3V~380V 220V、380	AD11-25/	电气原理图 Electric principle  尺寸图 Diagram  光谱图 SPECTRUM 
 Φ28 	10.2V-12V	24V、48V、110V 220V、380	AD11-30/	电气原理图 Electric principle  尺寸图 Diagram  光谱图 SPECTRUM 
 11×12 	4.4V-6.3V	6.3V~380V	AD116-D1 DZ47/C45	电气原理图 Electric principle  尺寸图 Diagram  光谱图 SPECTRUM 

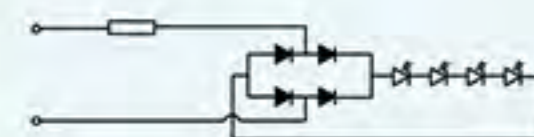
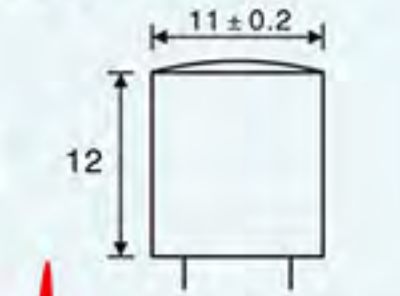
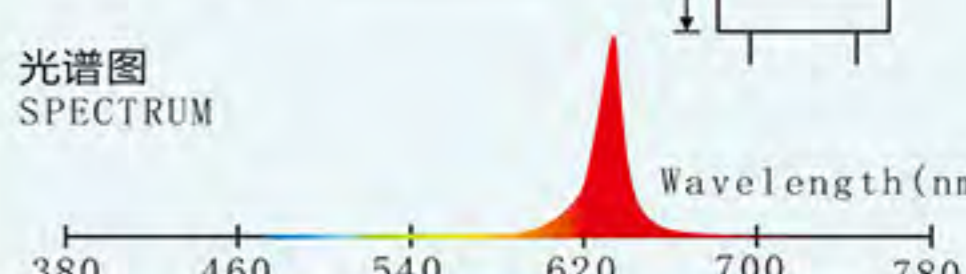
样式 (Photo)	灯头电压 (Head Voltage)	适配电压 (Suitable Assemble Voltage)	适合配置 (Set-up)	主要技术参数 (Main technical parameters)
 Φ25 	4.4V-10.4V	6.3V~380V	AD116-30 AD22-30	电气原理图 Electric principle  尺寸图 Diagram  光谱图 SPECTRUM 
 Φ9 	4.4V-6V	6.3V~380V	LA42- (Exclusive use)	电气原理图 Electric principle  尺寸图 Diagram  光谱图 SPECTRUM 
 φ11 	4.4V-5.4V	6.3V、12V	LA39、LA42	电气原理图 Electric principle  尺寸图 Diagram  光谱图 SPECTRUM 

简介 Brief introduction

该灯头采用进口LED发光芯片，环氧树脂封装，以先进工艺流程生产而成，具有颜色鲜艳、寿命长、耗电低、耐腐蚀和抗强烈振动等特点。

This type of lamp head is made of imported LED shining chip and sealed by epoxide resin. It has the characteristics of showy colour, long using life, low power consumption, corrosion-resisting and antivibration.



样式 (Photo)	型号 (Model)	电压 (Voltage)	颜色 (Color)	主要技术参数 (Main technical parameters)	
	7B/R/△	6.3V 110V	●	电气原理图 Electric principle 尺寸图 Diagram 光谱图 SPECTRUM Wavelength (nm)	
	7B/G/△	12V 127V	●		
	7B/Y/△	24V 220V	●		
	7B/B/△	36V 240V	●		
	7B/W/△	48V	○		
	BA9SA/R/△	6.3V 110V	●	电气原理图 Electric principle 尺寸图 Diagram 光谱图 SPECTRUM Wavelength (nm)	
	BA9SA/G/△	12V 127V	●		
	BA9SA/Y/△	24V 220V	●		
	BA9SA/B/△	36V 240V	●		
	BA9SA/W/△	48V	○		
	BA9SB/R/△	6.3V 110V	●	电气原理图 Electric principle 尺寸图 Diagram 光谱图 SPECTRUM Wavelength (nm)	
	BA9SB/G/△	12V 127V	●		
	BA9SB/Y/△	24V 220V	●		
	BA9SB/B/△	36V 240V	●		
	BA9SB/W/△	48V	○		
	BA9SC/R/△	6.3V 110V	●	电气原理图 Electric principle 尺寸图 Diagram 光谱图 SPECTRUM Wavelength (nm)	
	BA9SC/G/△	12V 127V	●		
	BA9SC/Y/△	24V 220V	●		
	BA9SC/B/△	36V 240V	●		
	BA9SC/W/△	48V	○		
	F11/R/△	6.3V 110V	●	电气原理图 Electric principle 尺寸图 Diagram 光谱图 SPECTRUM Wavelength (nm)	
	F11/G/△	12V 127V	●		
	F11/Y/△	24V 220V	●		
	F11/B/△	36V 240V	●		
	F11/W/△	48V	○		
	G10/R/△	6.3V 110V	●	电气原理图 Electric principle 尺寸图 Diagram 光谱图 SPECTRUM Wavelength (nm)	
	G10/G/△	12V 127V	●		
	G10/Y/△	24V 220V	●		
	G10/B/△	36V 240V	●		
	G10/W/△	48V	○		

样式 (Photo)	型号 (Model)	电压 (Voltage)	颜色 (Color)	主要技术参数 (Main technical parameters)	
	E10A/R/△	6.3V 110V	●	电气原理图 Electric principle 尺寸图 Diagram 光谱图 SPECTRUM Wavelength (nm)	
	E10A/G/△	12V 127V	●		
	E10A/Y/△	24V 220V	●		
	E10A/B/△	36V 240V	●		
	E10A/W/△	48V	○		
	E10C/R/△	6.3V 110V	●	电气原理图 Electric principle 尺寸图 Diagram 光谱图 SPECTRUM Wavelength (nm)	
	E10C/G/△	12V 127V	●		
	E10C/Y/△	24V 220V	●		
	E10C/B/△	36V 240V	●		
	E10C/W/△	48V	○		
	E12/R/△	6.3V 110V	●	电气原理图 Electric principle 尺寸图 Diagram 光谱图 SPECTRUM Wavelength (nm)	
	E12/G/△	12V 127V	●		
	E12/Y/△	24V 220V	●		
	E12/B/△	36V 240V	●		
	E12/W/△	48V	○		

型号及含义 Model and meaning



AD116系列信号灯 AD116 Series Indicator Lamp

导轨式信号灯型号说明 Model & Explanation

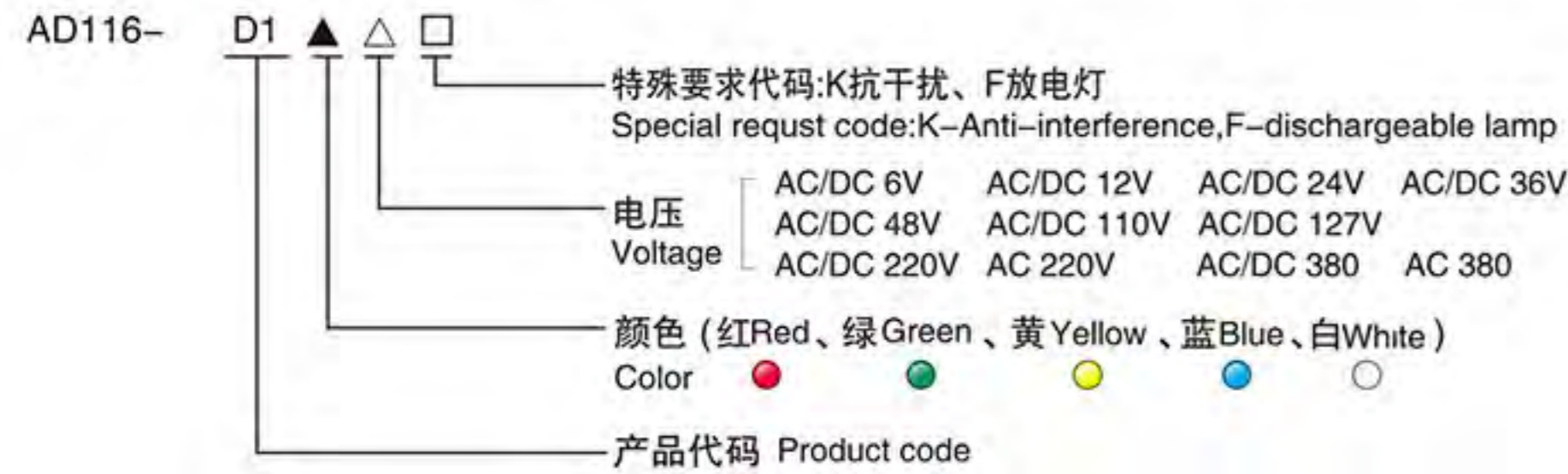

导轨式信号灯 DIN-rail type indicator

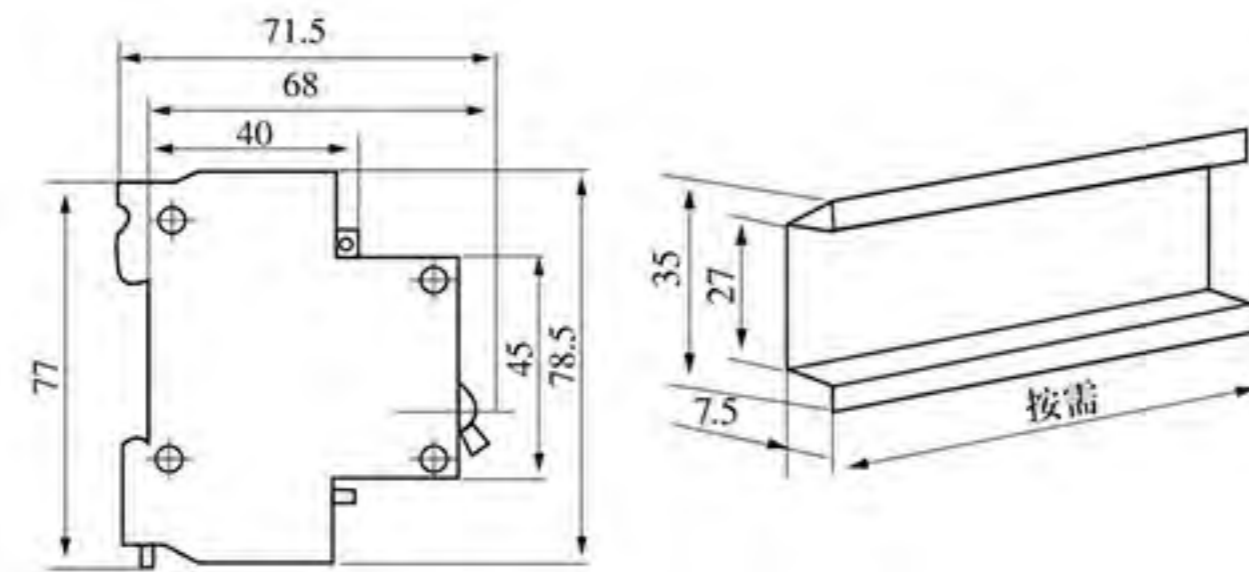

CJX2-(LC1-D) 系列交流接触器 CJX2-(LC1-D) Series AC Contactor

适用范围 Application

CJX2-(LC1-D)系列交流接触器适用于交流50Hz(或60Hz), 额定电压至660V, 额定电流至95A的电路中作为接通与分断电路及频繁启动与控制交流电动机之用。与辅助触点排、延时及机械连锁装置等组合时, 可作为延时接触器、机械连锁接触器及星三角启动器。可与热继电器组合成电磁启动器。产品的生产符合IEC947-2、VDE0660及BS5452标准。

CJX2-(LC1-D) series AC contactor is suitable for using in the circuits up to the rated voltage 660V AC 50Hz or 60Hz, rated current up to 95A, for making, breaking, frequently starting & controlling the AC motor. Combined with the auxiliary contact block, timer delay & machine interlocking device etc, it becomes the delay contactor, mechanical interlocking contactor, star-delta starter. With the thermal relay, it is combined into the electromagnetic starter. The Contactor is produced according to IEC947-2 VDE0660 & BS5452.



CJX2-(LC1-D)09,12



CJX2-(LC1-D)25



CJX2-(LC1-D)80,95

规格 Specification

型号 Type		CJX2-(LC1-D)09	CJX2-(LC1-D)12	CJX2-(LC1-D)18	CJX2-(LC1-D)25	CJX2-(LC1-D)32
额定工作 Rated working	AC3	9	12	18	25	32
电流 Current(A)	AC4	3.5	5	7.7	8.5	11
AC3三相容量 AC3 capacity of phase	220/230V	2.2	3	4	5.5	7.5
三相鼠笼式电动机 3 squirrel-cage motor	380/400V	4	5.5	7.5	11	15
AC3 (kW)	415V	4	5.5	9	11	15
	440V	4	5.5	9	11	15
	500V	5.5	7.5	10	15	18.5
	660/690V	5.5	7.5	10	15	18.5
额定热电流 Rated thermal current(A)	AC4×10 ⁴	20	20	32	40	50
电气寿命 Electrical life	AC3×10 ⁶	20	20-15	20-7	15-7	15-7
		2	2	2	2	2
机械寿命 Mechanical life×10 ⁶		20	20	20	20	20
触点数量 Number of the contacts		3P+NO				
		3P+NC				

型号 Type		CJX2-(LC1-D)40	CJX2-(LC1-D)50	CJX2-(LC1-D)65	CJX2-(LC1-D)80	CJX2-(LC1-D)95
额定工作 Rated working	AC3	40	50	65	80	95
电流 Current(A)	AC4	18.5	24	28	37	44
AC3三相容量 AC3 capacity of phase	220/230V	11	15	18.5	22	25
三相鼠笼式电动机 3 squirrel-cage motor	380/400V	18.5	22	30	37	45
AC3 (kW)	415V	22	25	37	45	45
	440V	22	30	37	45	45
	500V	22	30	37	55	55
	660/690V	30	33	37	45	45
额定热电流 Rated thermal current(A)		60	80	80	125	125
电气寿命 Electrical life	AC4×10 ⁴	10-7	7	7-6	7-5	7-5
	AC3×10 ⁶	2	2	1.6	1.6	1.6
机械寿命 Mechanical life×10 ⁶		20	20	20	10	10
触点数量 Number of the contacts		3P+NC+NO				

CJX2-(LC1-DN) 系列交流接触器 CJX2-(LC1-DN) Series AC Contactor

适用范围 Application

CJX2-(LC1-DN)系列交流接触器适用于交流50Hz(或60Hz), AC-3负载使用类别时额定工作电流为9-330A的电路中。该产品主要用于远距离接通和分断电力线路,亦用于交流电动机起动器的频繁起动、停车与控制。产品的生产符合IEC60947-4-1及GB14048.4标准。

CJX2-(LC1-DN) series AC contactors are suitable for frequency 50/60Hz, rated operation current 9-330A under AC-3 duty. It is mainly used for making/breaking electric circuits at a long distance. And for frequent starting/stopping and controlling AC motor starter. The products are produced according to IEC 60947-4-1 & GB14048.4.



CJX2-(LC1-DN)09,12,18



CJX2-(LC1-DN)25,32,38



CJX2-(LC1-DN)40,50,65

规格 Specification

额定工作电流 Rated operational current							
le max AC-3(UesV)		9A	12A	18A	25A	32A	38A
le AC-1 (0≤60°C)		25A		32A	40A	50A	
额定绝缘电压 Rated insulation voltage		690V					
极数 Number of poles		3	3 4	3	3 4	3	
额定工作 Rated operational	220/240V	2.2KW	3KW	4KW	5.5KW	7.5KW	9KW
	380/400V	4KW	5.5KW	7.5KW	11KW	15KW	18.5KW
AC-3 类别时功率 Power in AC-3	415/440V	4KW	5.5KW	9KW	11KW	15KW	18.5KW
	550V	5.5KW	7.5KW	10KW	15KW	18.5KW	18.5KW
	600/690V	5.5KW	7.5KW	10KW	15KW	18.5KW	18.5KW
	1000V	-	-	-	-	-	-
变阻器 Auxiliary contacts	辅助触点范围: 至多4常闭或常开瞬时, 至多1常开+1常闭延时, 至多2常开保护触点与2屏接线端子可兼容手动或自动热过载继电器。 range comprising up to 4 NC or NO instantaneous, up to 1NO+1NC time delay and up to 2NO protected contacts and 2 screen continuity terminals						
可兼容手动或自动热过载继电器 Compatible manual or auto thermal overload relays	Class 10A	0.10...10A	0.10...13A	0.10...18A	0.10...32A	0.10...38A	0.10...38A
	Class 20A	2.5...10A	2.5...13A	2.5...18A	2.5...32A	-	-
抑制器模块(直流与低功耗 接触器内置浪涌抑制二极管) Suppressor modules (d.c. and low consumption contactors have built-in suppression limiting diode as standard)	变阻器 Varistor	•	• •	•	• •	•	•
	二极管 Diode	-	- •	-	- •	-	-
	RC电路 RC circuit	•	• •	•	• •	•	•
	双向限流 Bidirectional peak	•	• •	•	• •	•	•
继电器 Relay		•	• •	•	• •	•	•
接口 Interfaces	继电器+过载功能 Relay+override function	•	• •	•	• •	•	•
	固态 Solid state	•	• •	•	• •	•	•
接触器型号参考 Contactor type references	~OF~3P	CJX2-(LC1-D)09	CJX2-(LC1-D)12	CJX2-(LC1-D)18	CJX2-(LC1-D)25	CJX2-(LC1-D)32	CJX2-(LC1-D)38
	~4-P	-	CJX2-(LC1-D)12	-	CJX2-(LC1-D)25	-	-
	~4P	-	CJX2-(LC1-D)12	-	CJX2-(LC1-D)25	-	-
可逆接触器型号参考 Reversing contactor type references	~3P	CJX2-(LC1-D)09	CJX2-(LC1-D)12	CJX2-(LC1-D)18	CJX2-(LC1-D)25	CJX2-(LC1-D)32	CJX2-(LC1-D)38
	~3P	CJX2-(LC1-D)09	CJX2-(LC1-D)12	CJX2-(LC1-D)18	CJX2-(LC1-D)25	CJX2-(LC1-D)32	CJX2-(LC1-D)38
	~4P	-	CJX2-(LC1-D)12	-	CJX2-(LC1-D)25	-	-
	~4P	-	CJX2-(LC1-D)12	-	CJX2-(LC1-D)25	-	-
	~4P	-	CJX2-(LC1-D)12	-	CJX2-(LC1-D)25	-	-
	~4P	-	CJX2-(LC1-D)12	-	CJX2-(LC1-D)25	-	-

F4-(LA1) 系列触头块 F4-(LA1) Series Contact Blocks

适用范围 Application

F4-(LA1) 系列辅助触点排安装在CJX2-(LC1-D)控制继电器或CJX2-(LC1-D)交流接触器顶部以容纳更多辅助触点。采用触点的滑动摩擦功能,该产品可自行清洁以确保电力线路的可靠性。

F4-(LA1) series auxiliary contact blocks are installed on the top of CJX2-(LC1-D) control relay or CJX2-(LC1-D) AC contactor for more auxiliary contacts. Adopting the contact functions of sliding frictions, the item can be self-cleaning and ensure the electric circuit to be reliable.

规格 Specification

型号 Type	F4-(LA1) DN02	F4-(LA1) DN11	F4-(LA1) DN20	F4-(LA1) DN22	F4-(LA1) DN40	F4-(LA1) DN04	F4-(LA1) DN13	F4-(LA1) DN31
触点数量 Contact number	2NC	NO+NC	2NO	2NO+2NC	4NO	4NC	1NO+3NC	3NO+1NC



F4-(LA1-D)11



F4-(LA1-D)22



F4-(LA1-D)02

接线图 Wiring Diagram

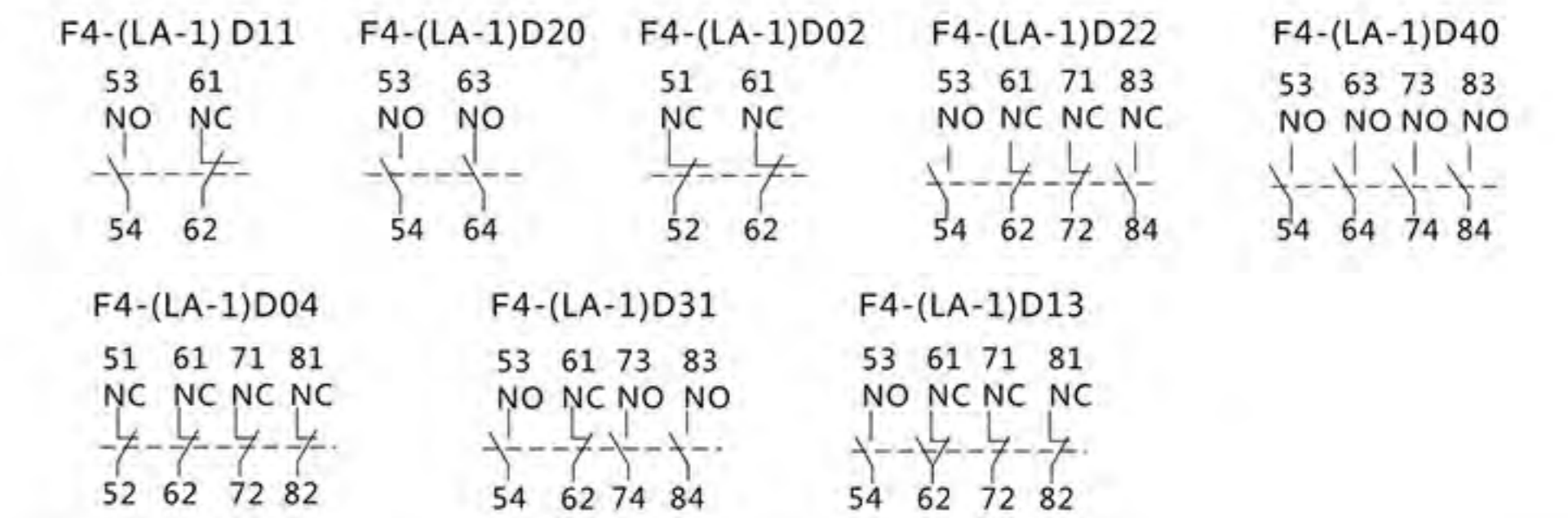

F4-(LA2) 系列触头块
F4-(LA) Series Contact Blocks

适用范围 Application

F4-(LA2) 延时辅助触点排用于与CJX2-(LC1-D)交流接触器与F4-(LA1)辅助触点排组成LC3星三角降压起动器以起动电动机。

F4-(LA2) time delay auxiliary contact blocks are used with CJX2-(LC1-D) AC contactor and LA1 auxiliary contact block to form S-LC3 star delta reduced voltage starter to start motor.

规格 Specification

型号 Type	延时范围 Delay range	延时触点数量 Number of the delay contacts
F4-(LA2)T0	0.1~3s	NO+NC
F4-(LA2)T2	0.1~30s	
F4-(LA2)T4	10~180s	
F4-(LA2)R2	0.1~30s	
F4-(LA2)R4	10~180s	
F4-(LA2)R0	0.1~3s	

外型及安装尺寸 Outline and Installation Dimension



CJX2-N 机械联锁接触器 CJX2-N Mechanical Interlocking Contactor



CJX2-09N



CJX2-32N



CJX2-50N



CJX2-80N

适用范围 Application

该接触器主要适用于交流50Hz(或60Hz), 额定电压至660V的的电路中控制电路。其机械连锁装置可确保两只可逆接触器之间触点的转换。

The contactor is suitable for using in the circuits up to the rated voltage 660V AC 50Hz or 600Hz, controlling the motor. It's mechanical interlocking device ensures contact changeover of the two convertible contactors.

规格 Specification

型号 Type	电气寿命(万次) Electric life (ten thousand times)	额定电流(A) Rated current(A)	
		220V-380V	500V-600V
CJX2-09N	20	3.5	1.5
CJX2-12N	20	5	2
CJX2-18N	20	7.7	3.8
CJX2-25N	20	8.5	4.4
CJX2-32N	20	12	7.5
CJX2-40N	15	18.5	9
CJX2-50N	15	24	12
CJX2-63N	15	28	14
CJX2-80N	10	37	17.3
CJX2-95N	10	44	21.3

型号 Size: CJX2-N	最高额定电压 Maximum rated voltage	最高热电流1th Maximum thermal current 1th	最高额定电流 LL: 长寿命/NL: 普通寿命 3ph 440V 50/60Hz Maximum rated current LL: Long life/NL: Normal life 3ph 440V 50/60Hz	AC3负载下最大标准功率等级 Maximum standard power rating under AC 3 duty					
				220V		380V		415/440V	
				KW	hp	KW	hp	hp	KW
115N	1000V	200A	-	-	-	-	-	-	
1154N	1000V	200A	NL120A	30	40	55	75	60	80
			LL115A	30	40	55	75	60	80
185N	1000V	270A	NL150A	45	60	75	100	80	110
			LL185A	55	75	90	125	100	135
1854N	1000V	270A	LL185A	55	75	90	125	100	135
			NL205A	63	85	110	150	110	150
365N	1000V	350A	NL265A	75	100	132	180	140	190
			LL265A	75	100	132	180	140	190
3654N	1000V	350A	NL300A	90	125	160	220	160	220
			LL400A	110	150	200	270	220	300
400N	1000V	500A	LL400A	110	150	200	270	220	300
			NL450A	132	180	220	300	250	340
4004N	1000V	500A	LL500A	147	200	250	340	280	380
			NL630A	185	250	335	450	355	480
500N	1000V	700A	LL630A	200	270	335	450	375	500
			NL1000A	220	300	400	540	450	610
630N	1000V	1000A	LL800A	220	300	400	540	425	570
			LL780A	280	380	500	680	530	720

QJX2 星三角起动机 Star-delta starter



QJX2技术参数 Technial parameters

型号 Type	主回路接触器 Main return circuit of contactor			热过载继电器 Thermal overload relay		控制电机功率 Controlling power(KW)				额定工作电流 (Ie)Rated operating current (AC-3 380V)	配熔断器 NTOO
	隔离用 KM2	△运转 KM3	Y运转 KM1	电流整定范围 Range of current(A)	型号 Type	220V	380V	415V	660V		
QJX2-12	QJX2-1210	QJX2-1201	QJX2-0901	9-13	JRS4-1310	5.5	11	11	11	20	20
QJX2-18	QJX2-1810	QJX2-1801	QJX2-1201	12-18	JRS4-1321	7.5	15	15	22	31	32
QJX2-25	QJX2-2510	QJX2-2501	QJX2-1201	17-25	JRS4-1322	11	18.5	22	25	43	50
QJX2-32	QJX2-3210	QJX2-3201	QJX2-2501	23-32	JRS4-2353	15	25	25	30	55	63
QJX2-40	QJX2-4011	QJX2-4011	QJX2-2501	30-40	JRS4-3355	18.5	33	37	37	69	80
QJX2-50	QJX2-5011	QJX2-5011	QJX2-4011	37-50	JRS4-3357	25	45	45	55	86	100
QJX2-65	QJX2-6511	QJX2-6511	QJX2-4011	55-70	JRS4-3361	30	55	59	59	112	125
QJX2-80	QJX2-8011	QJX2-8011	QJX2-5011	63-80	JRS4-3363	40	75	75	75	138	160
QJX2-95	QJX2-9511	QJX2-9511	QJX2-6511	80-95	JRS4-3365	40	80	80	80	164	200

CJ19切换电容器接触器 Capacitor contactor



产品型号 Type	CJ19-25	CJ19-32	CJ19-43	CJ19-45	CJ19-50	CJ19-63	CJ19-80	CJ19-95		
额定工作电流(Ie) Rated operating current AC3 Ue ≤440V	A 18	25	32	40	48	63	80	95		
约定发热电流(Ith) Conventional heating current AC1.0 ≤40°	A 25	32	43	48	50	63	80	95		
可控容量(Qn) AC-6b Controlling capacitor	Kvar	220-230V	6.5	8.5	10	13	16	20	25	30
		400-415V	12	17	20	25	28	32	40	48
控制涌流能力(限流能力) Restrain flow ability	倍	15	15	15	15	15	15	15		
额定工作电压(Ue) Rated working voltage max	V 380,660	380,660	380,660	380,660	380,660	380,660	380,660	380,660		
额定绝缘电压(Ui) Rated insulating voltage	V 690	690	690	690	690	690	690	690		
机械寿命 Mechanical life	10 ⁴ 次	100	100	100	100	100	100	100		
电寿命 Electric life	10 ⁴ 次	12	12	10	10	10	10	10		
操作频率 Operating frequency	次/h	120	120	120	120	120	120	120		
体积 Volume H × L × W	mm ³	120×	140×	140×	170×	170×	170×	190×	190×	
		125×46	135×56	135×56	150×76	150×76	150×76	160×86	160×86	

LR1、LR2系列热继电器 LR1、LR2 SERIES THERMAL RELAY

用途及适用范围 INTRODUCTION AND APPLICATIONS

JRS1(LR1-D)系列热过载继电器适用于交流50或60Hz,电压至660V,电流至80A及以下的电路中,供交流电动机热保护用。并且有差动机构和温度补偿环节,可与CJX2(LC1-D)交流接触器配装,也可独立安装。

JRS1(LR1-D)series thermal relay is suitable for using in the circuits rated voltage up to 660V, rated current 93A AC 50Hz or 60Hz, for over-voltage protection of A.C. motor. The relay has the differential mechanism and temperature compensation and can plug in CJX2(LC1-D) series A.C. contactor.



JRS1-09-25(LR1)



JRS1-40-80(LR1)



JR28-25(LR2D13)



JR28-36(LR2D23)



JR28-93(LR2D33)

动作特性：三相负载平衡时的动作时间

MOTION CHARACTERISTIC：THREE-PHASE BALANCE MOTION TIME

序号 No	整定电流倍数 Set current cinles	动作时间 Motion time	起始条件 Start condition	环境温度 Temperature
1	10.5	>2h	冷态 cold state	20±5°C
2	1.2	<2h	热态 heat state (接序号1试验后 Following the No.1 test)	
3	1.5	<4min		
4	7.2	10A 2s<Tp≤10s ≤63A 10A 4s<Tp≤10s >63A	冷态 cold state	

断相动作性能 PHASE-LOSING MOTION CHARACTERISTIC

序号 No	整定电流倍数 Set current cinles		动作时间 Motion time	起始条件 Start condition	环境温度 Temperature
	任意二相 Arbitrary two phase	第三相 Three phase			
1	1.0	0.9	>2h	冷态 cold state	20±5°C
2	1.15	0	<2h	热态 heat state (接序号1试验后 Following the No.1 test)	

JR2-D 系列热过载继电器用于交流50或60Hz,电压至660V,电流至93A及以下的电路中,供交流电动机热保护用。并且有差动机构和温度补偿环节,可与CJX2(LC1-D)交流接触器配装,也可独立安装。

JR2-D series thermal relay is suitable for using in the circuits rated voltage up to 660V, rated current 93A AC 50Hz or 60Hz, for over-voltage protection of A.C. motor. The relay has the differential mechanism and temperature compensation and can plug in CJX2(LC1-D) series A.C. contactor.

规格 SPECIFICATIONS

型号 Type	编号 Number	整定电流范围(A) Setting Range(A)	可插接安装的接触器 Contactors insert	型号 Type	编号 Number	整定电流范围(A) Setting Range(A)	可插接安装的接触器 Contactors insert
LR1-D	09301	0.1~0.16	DC09-D25	LR2-D	1301	0.1~0.16	D09-D25
	09302	0.16~0.25	DC09-D25		1302	0.16~0.25	D09-D25
	09303	0.25~0.4	DC09-D25		1303	0.25~0.4	D09-D25
	09304	0.4~0.63	DC09-D25		1304	0.4~0.63	D09-D25
	09305	0.63~1	DC09-D25		1305	0.63~1	D09-D25
	09306	1~1.6	DC09-D25		1306	1~1.6	D09-D25
	09307	1.6~2.5	DC09-D25		1307	1.6~2.5	D09-D25
	09308	2.5~4	DC09-D25		1308	2.5~4	D09-D25
	09310	4~6	DC09-D25		1310	4~6	D09-D25
	09312	5.5~8	DC09-D25		1312	5.5~8	D09-D25
	09314	7~10	DC09-D25		1314	7~10	D09-D25
	12316	10~13	DC09-D25		1316	9~13	D09-D25
	16321	13~18	DC09-D25		1321	12~18	D09-D25
	25322	18~25	DC09-D25		1322	17~25	D32
	40353	23~32	DC09-D25		2353	23~32	D25-D32
	40355	30~40	D40、D50、D63		2355	30~40	D25-D32
	63357	38~50	D40、D50、D63		3322	17~25	D40-D95
	63359	48~57	D40、D50、D63		3353	23~32	D40-D95
63361	57~66	D40、D50、D63	3355	30~40	D40-D95		
80363	63~80	D40、D50、D63	3357	37~50	D40-D95		
			3359	48~65	D40-D95		
			3361	55~70	D40-D95		
			3363	63~80	D40-D95		
			3365	80~93	D95		

外形及安装尺寸 OUTLINE AND MOUNTING DIMENSIONS

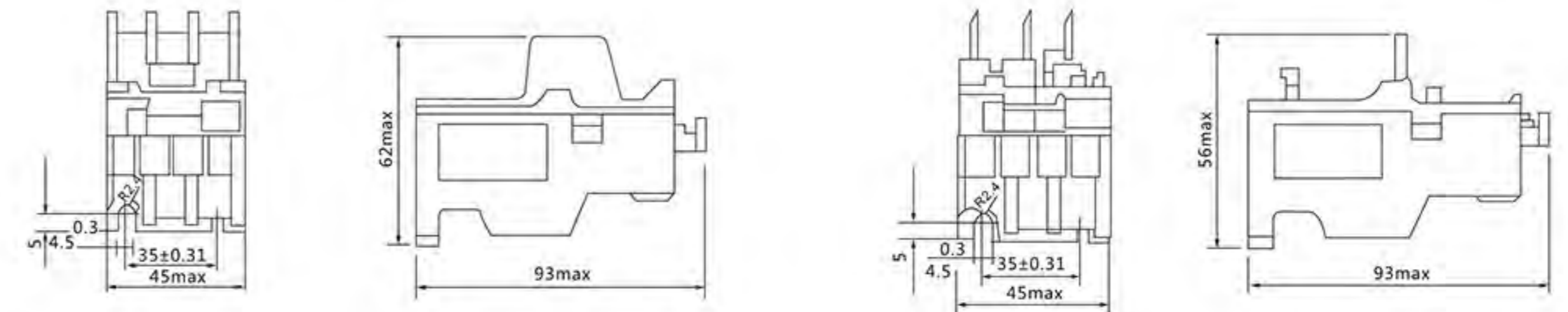

LR1-09-25

(F型)

(Z型)

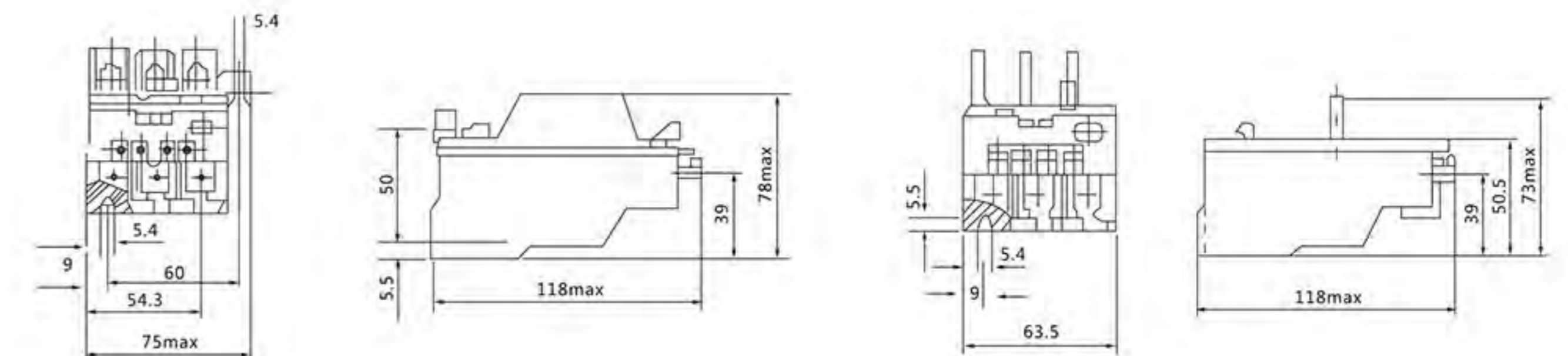

LR1-40-80

(F型)

(Z型)

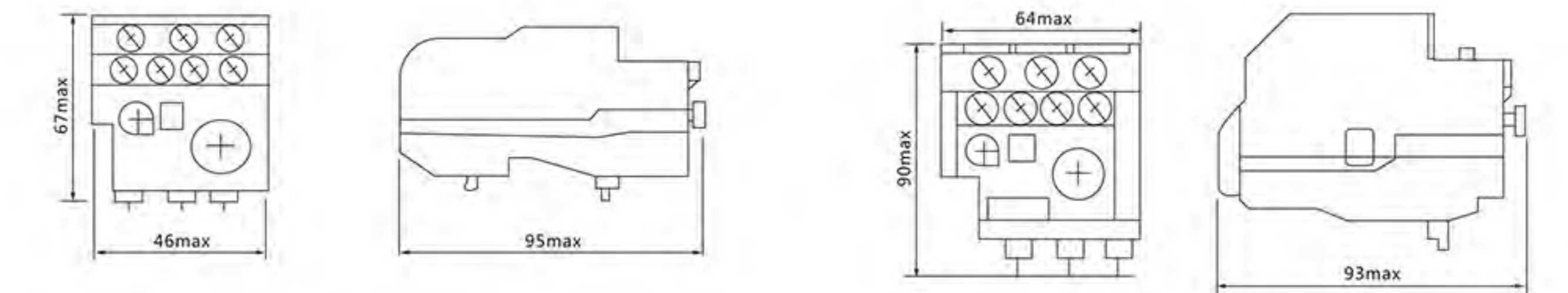

LR2-D13

LR2-D23

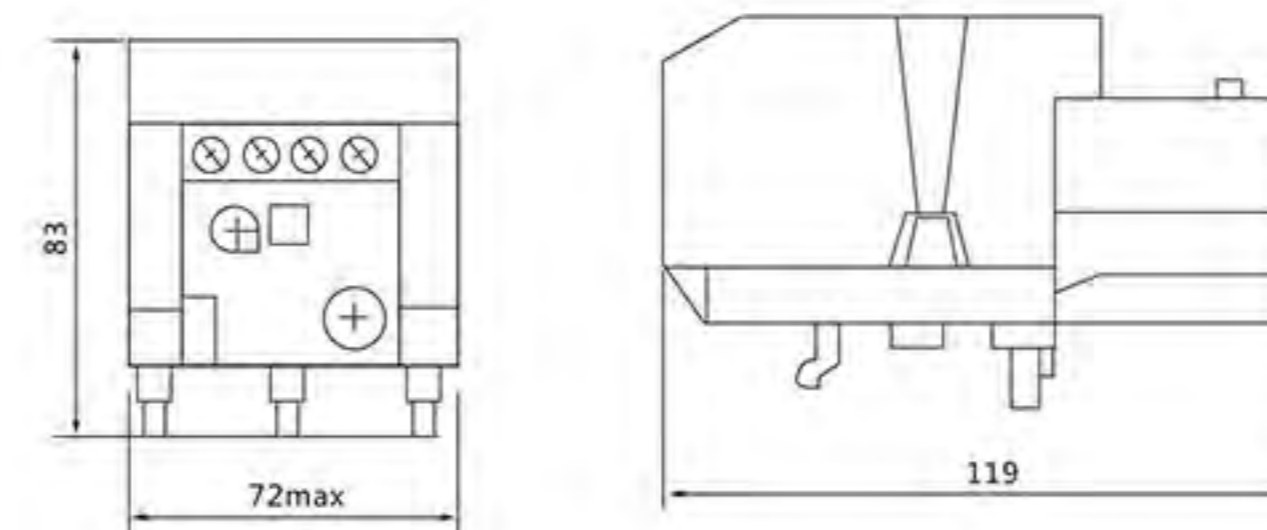

LR2-D33

QCX2 磁力起动器 Magmetic starters



产品型号 Type	QCX2-09	QCX2-12	QCX2-18	QCX2-25	QCX2-32	QCX2-40	QCX2-50	QCX2-63	QCX2-80	QCX2-95	
额定绝缘电压(Ui)Rated insulating voltage(V)	690	690	690	690	690	690	690	690	690	690	
额定工作电流(Ie)(A)	380V 8.5	11.5	15.5	22	30	37	44	60	72.5	85	
Rated operating current AC3 Ue ≤ 440V	660V 6.6	8.9	12	18	21.3	34.6	39	42	49	49	
约定发热电流(Ith) Conventional heating current AC1 0≤40°	380V 25	25	32	40	50	60	80	80	125	125	
可控三相鼠笼电动机功率 Power of controllable 3-phase squirrel-cage motor(AC3) KW	220V 2.2	3	4	5.5	7.5	11	15	18.5	22	25	
	380V 4	5.5	7.5	11	15	18.5	22	30	37	45	
	660V 5.5	7.5	10	15	18.5	30	33	37	45	55	
寿命 Life	机械寿命 Mechanical life 10 ⁴ 次	600	600	600	600	600	600	600	600	600	
	电寿命 Electric life 10 ⁴ 次	100	100	80	80	80	60	60	60	60	
辅助触头 Auxiliary contactor block	约定发热电流(Ith) Conventional heating current	6	6	6	6	6	6	6	6	6	
	控制功率 Control power	AX-11 VA	300	300	300	300	300	300	300	300	300
		DC-11 W	30	30	30	30	30	30	30	30	30
体积 Volume H × L × W (m ³)	166× 140×90	166× 140×90	166× 140×90	166× 140×104	166× 140×104	315× 170×185	315× 170×185	315× 170×185	315× 170×185	315× 170×185	

Pushbuttons Momentary

Photo	Technical parameters	Electrical schematic	Diemension
	动力用押扣按钮开关 BS Pushbutton switch Ue:AC 380V Ui:500V Ie:4A 1.5KW		
	动力用押扣按钮开关 BS Pushbutton switch Ue:AC 380V Ui:500V Ie:6A 2.2KW		
	动力用押扣按钮开关 BS Pushbutton switch Ue:AC 380V Ui:500V Ie:10A 3.7KW		

样式 Photo	描述 Description	型号 Type	尺寸 Contour
	Button box for single hole IP65 一孔按钮盒	TOB-1A-GW TOB-1A-YW	 ① 2Φ21.8mm敲落孔, 最佳线径6-12mm ② Φ19mm敲落孔, 底部进线 ③ Φ14.3mm敲落孔, 底部进线 ④ 2Φ4.8mm安装孔
	Button box for two hole IP65 二孔按钮盒	TOB-2A-GW	 ① 2Φ21.8mm敲落孔, 最佳线径6-12mm ② 2Φ19mm敲落孔, 底部进线 ③ 2Φ4.8mm安装孔 ④ n: 孔数
	Button box for three hole IP65 三孔按钮盒	TOB-3A-YW	
	Button box for four hole IP65 四孔按钮盒	TOB-4A-GW	
	Button box for five hole IP65 五孔按钮盒	TOB-5A-YW	
	Button box for six hole IP65 六孔按钮盒	TOB-6A-GW	
	带防水接头 带加长型防水接头 一孔按钮盒 Button box for single hole	TOB-1A-GW/P TOB-1A-YW/H	

控制盒/行程开关系列
Control box/Travel switch series

控制盒/行程开关系列
Control box/Travel switch series

样式 Photo	描述 Description	型号 Type	尺寸 Contour
	1 green flush pushbutton spring return IP65	TOB-1A01M-GW	
	1 绿色复位按钮	TOB-1A02-GW	
		TOB-1A03-GW	
		TOB-1A01-GW	
	1 red flush pushbutton spring return IP65	TOB-1A11M-GW	
	1 红色复位按钮	TOB-1A12-GW	
		TOB-1A13-GW	
		TOB-1A11-GW	
	1 selector switch 2-position stay put standard IP65	TOB-1A21M-GW	
	1 二位置自锁定按钮	TOB-1A22-GW	
		TOB-1A20-GW	
	1 red mushroom head pushbutton spring return IP65	TOB-1A60M-GW	
	1 红色蘑菇头复位按钮	TOB-1A60-GW	
	1 red mushroom head pushbutton turn to release or push-pull IP65	TOB-1A70M-YW	
	可旋转复位和拉拔复位急停按钮	TOB-1A70-YW	
	1 red mushroom head pushbutton turn to release or push-pull IP65	TOB-1A71M-YW	
	可旋转复位和拉拔复位急停按钮	TOB-1A71-YW	

Explanation of Type Designation(型号命名方式解释)

Example(示例):



GOB-1 A 0 1M-YW / P

- Gable gland styles 电缆接头类型
- Y, in it denotes yellow cover Y,代表黄色上盖
- W, in it denotes white base W,代表白色底座
- G, in it denotes dark grey cover G,代表深灰色上盖
- Button symbol code 按钮符号代码
- Button box styles 按钮盒款式
- The number of holes 孔数
- Button box series 按钮盒系列

样式 Photo	描述 Description	型号 Type	尺寸 Contour
	1 selector switch with key operated 2-position stay put IP65	TOB-1A42M-GW	
	1 二位置自锁定按钮	TOB-1A42-GW	
	2 spring return pushbuttons 1 flush green 1 flush red IP65	TOB-2A10M-GW	
	1 绿色复位按钮 1 红色复位按钮	TOB-2A12-GW	
		TOB-2A13-GW	
		TOB-2A10-GW	
	2 spring return pushbuttons 2 flush black white arrow IP65	TOB-2A22-GW	
	2 黑色复位按钮 (白箭头)	TOB-2A23-GW	
	1 red pilot light 2 spring return push buttons 1 flush green 1 flush red IP65	TOB-3A11M-GW	
	1 红色指示灯 1 红色复位按钮 1 绿色复位按钮	TOB-3A12-GW	
		TOB-3A13-GW	
		TOB-3A11-GW	
	3 spring return pushbuttons 1 flush red 2 flush black white arrow IP65	TOB-3A22-GW	
	1 红色复位按钮 2 黑色复位按钮 (白箭头)	TOB-3A23-GW	
	3 spring return pushbuttons 1 flush green 1 flush red 1 flush green IP65	TOB-3A11M-GW	
	1 绿色复位按钮 1 红色复位按钮 1 绿色复位按钮	TOB-3A10-GW	
		TOB-3A12M-GW	
		TOB-3A12-GW	

样式 Photo	描述 Description	型号 Type	尺寸 Contour
	两钮联锁、自动复位、常开动合按钮 Two-button interlock, automatic reset, (two on)	Ui:500V Ith:10A AC-15 500V~2A 250V~5A TOB1-X271 TOB1-X281 TOB1-X291	
	推锁旋转紧急停止按钮 两钮联锁、自动复位 Push lock revolve urgent stop button; one off (one off two on)	Ui:500V Ith:10A AC-15 500V~2A 250V~5A TOB1-X2713 TOB1-X2813 TOB1-X2913	
	两钮联锁、自动复位、常开动合按钮 Two-button interlock, automatic reset, (four on)	Ui:500V Ith:10A AC-15 500V~2A 250V~5A TOB1-X471 TOB1-X481 TOB1-X491	
	推锁旋转紧急停止按钮 两钮联锁、自动复位 Push lock revolve urgent stop button; one off (one off four on)	Ui:500V Ith:10A AC-15 500V~2A 250V~5A TOB1-X4713 TOB1-X4813 TOB1-X4913	
	两钮联锁、自动复位、常开动合按钮 Two-button interlock, automatic reset, (six on)	Ui:500V Ith:10A AC-15 500V~2A 250V~5A TOB1-X671 TOB1-X681 TOB1-X691	
	推锁旋转紧急停止按钮 两钮联锁、自动复位 Push lock revolve urgent stop button; one off (one off six on)	Ui:500V Ith:10A AC-15 500V~2A 250V~5A TOB1-X6713 TOB1-X6813 TOB1-X6913	
	两钮联锁、自动复位、常开动合按钮 Two-button interlock, automatic reset, (eight on)	Ui:500V Ith:10A AC-15 500V~2A 250V~5A TOB1-X871 TOB1-X881 TOB1-X891	

样式 Photo	描述 Description	型号 Type	尺寸 Contour
	推锁旋转紧急停止按钮 两钮联锁、自动复位 Push lock revolve urgent stop button; one off (one off eight on)	Ui:500V Ith:10A AC-15 500V~2A 250V~5A TOB1-X8713 TOB1-X8813 TOB1-X8913	
	两钮联锁、自动复位、常开动合按钮 Two-button interlock, automatic reset, (nine on)	Ui:500V Ith:10A AC-15 500V~2A 250V~5A TOB1-X1071 TOB1-X1081 TOB1-X1091	
	推锁旋转紧急停止按钮 两钮联锁、自动复位 Push lock revolve urgent stop button; one off (one off nine on)	Ui:500V Ith:10A AC-15 500V~2A 250V~5A TOB1-X10713 TOB1-X10813 TOB1-X10913	
	两钮联锁、自动复位、常开动合按钮 Two-button interlock, automatic reset, (eleven on)	Ui:500V Ith:10A AC-15 500V~2A 250V~5A TOB1-X1271 TOB1-X1281 TOB1-X1291	
	推锁旋转紧急停止按钮 两钮联锁、自动复位 Push lock revolve urgent stop button; one off (one off eleven on)	Ui:500V Ith:10A AC-15 500V~2A 250V~5A TOB1-X12713 TOB1-X12813 TOB1-X12913	
	两钮联锁、自动复位 Buttons inter lock and auto reset	Ui:500V Ith:5A AC-15 500V~2A 250V~5A TOB2-61	
	两钮联锁、自动复位 Buttons inter lock and auto reset	Ui:500V Ith:5A AC-15 500V~2A 250V~5A TOB2-62 TOB2-61B	

样式 Photo	描述 Description	型号 Type	尺寸 Contour
	两钮联锁、自动复位 Buttons inter lock and auto reset Ui:500V Ith:5A AC-15 500V~2A 250V~5A	TOB2-63 TOB2-62B	
	两钮联锁、自动复位 Buttons inter lock and auto reset Ui:500V Ith:5A AC-15 500V~2A 250V~5A	TOB2-64 TOB2-63B	
	两钮联锁、自动复位 Buttons inter lock and auto reset Ui:500V Ith:5A AC-15 500V~2A 250V~5A	TOB2-65 TOB2-64B	
	ON(开)常开自锁 由OFF驱动复位 两钮联锁、自动复位 Normal-on and self-lock reset is driven by off Two buttons inter lock self-reset,two couples normal-on-off Ui:500V Ith:5A AC-15 500V~2A 250V~5A	TOB2-61A	
	ON(开)常开自锁 由OFF驱动复位 两钮联锁、自动复位 Normal-on and self-lock reset is driven by off Two buttons inter lock self-reset,two couples normal-on-off Ui:500V Ith:5A AC-15 500V~2A 250V~5A	TOB2-62A	
	推锁旋转紧急停止按钮, 两钮联锁, 自动复位 Push lock revolve urgent stopbutton; one off(one off one on) Ui:500V~ Ith:10A AC-15 500V~2A 250V~5A	TOB2-61E TOB2-61ES TOB2-61EK TOB2-61ESK	
	带电容防雨型按钮 两钮联锁, 自动复位, Push lock revolve, with capacitor,two ON button, 16uf,30uf,40uf,50uf, others according to customer's requirement Ui:500V~ Ith:10A AC-15 500V~2A 250V~5A	TOB2-61DR	

塑料防水电缆接头M型
Plastic waterproof cable connector M type



产品型号 Model	适用电缆 Cable Range(mm)	螺纹外径 Thread O.D. AG(mm)	螺纹长度 Thread Length GL(mm)	扳手直径 Spanner Size(mm)
M12x1.5	3-6.5	12	8	16
M12x1.5	2-5	12	8	16
M16x1.5	4-8	16	8	19
M16x1.5	2-6	16	8	19
M18x1.5	5-10	18	8	22
M18x1.5	3-7	18	8	22
M20x1.5	6-12	20	10	24
M20x1.5	5-9	20	10	24
M22x1.5	10-14	22	10	27
M22x1.5	7-12	22	10	27
M24x1.5	12-16	24	10	27
M24x1.5	10-13	24	10	27
M25x1.5	13-18	25	10	33
M25x1.5	9-16	25	10	33
M27x1.5	13-18	27	10	33
M27x1.5	9-16	27	10	33
M30x1.5	16-21	30	11	35
M30x1.5	13-18	30	11	35
M32x1.5	16-21	32	11	35
M32x1.5	13-18	32	11	35
M36x1.5	18-25	36	12	42
M36x1.5	13-20	36	12	42
M40x1.5	22-32	40	14	52
M40x1.5	20-26	40	14	52
M50x1.5	32-38	50	14	60
M50x1.5	25-31	50	14	60
M63x1.5	37-44	63	15	64
M63x1.5	29-35	63	15	64
M71x1.5	42-50	71	28	77
M71x1.5	32-40	71	28	77

- 产品材质: 采用UL认可的尼龙PA66
- 密封件: 丁晴橡胶(NBR), 耐候橡胶(EPDM)
- 工作温度: 静态-40°C至100°C, 瞬时耐热至120°C, 动态-20°C至80°C, 瞬间耐热至100°C
- 防护等级: IP68(旋紧部位, 并使用O-密封圈)
- 颜色种类: 黑色(RAL9005)、浅灰(RAL7035), 特殊颜色可定做
- Material: Adopting nylon PA66 certificated by UL
- Weather strip: Nitrile butadiene rubber (NBR), Weathering-resistance rubber (EPDM)
- Working temperature: -40°C to 100°C in static state, instantaneous heat resistance up to 120°C; -20°C to 80°C in dynamic state, instantaneous heat resistance up to 100°C
- Characteristics: IP68(Rotate the part, and use O ring)
- Color: Black(RAL9005), light grey (RAL7035), as well as special colors that can be designed at request.

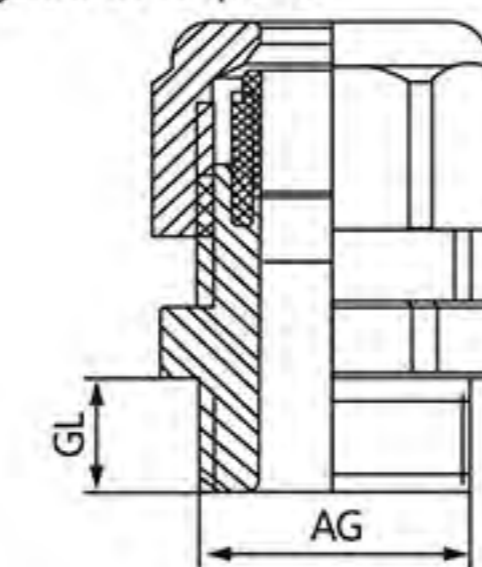

产品型号 Model	适用电缆 Cable Range(mm)	螺纹外径 Thread O.D. AG(mm)	螺纹长度 Thread Length GL(mm)	扳手直径 Spanner Size(mm)
PG7	3-6.5	12.5	8	16
PG7	2-5	12.5	8	16
PG9	4-8	15.2	8	19
PG9	2-6	15.2	8	19
PG11	5-10	18.6	8	22
PG11	3-7	18.6	8	22
PG13.5	6-12	20.4	10	24
PG13.5	5-9	20.4	10	24
PG16	10-14	22.5	10	27
PG16	7-12	22.5	10	27
PG19	12-16	24	10	27
PG19	10-13	24	10	27
PG21	13-18	28.3	10	33
PG21	9-16	28.3	10	33
PG25	16-21	30	11	35
PG25	13-18	30	11	35
PG29	18-25	37	12	42
PG29	13-20	37	12	42
PG36	22-32	47	14	52
PG36	20-26	47	14	52
PG42	32-38	54	14	60
PG42	25-31	54	14	60
PG48	37-44	59.3	15	64
PG48	29-35	59.3	15	64
PG63	42-50	71	28	77
PG63	32-40	71	28	77